



Design Guide for the Built Environment



Northumberland Coast AONB Design Guide for Built Development

Contents



Credits, Acknowledgments, References and Glossary	2
Introduction (and User Guide)	10
The Need for Design Guidance	13
The Character of the AONB	17
Design Criteria	46
Repair and Maintenance	56
Alterations and Extensions	70
Conversions	91
New Building	106
Landscape, Planting and External Detail	121
Caravan, Chalet and Camping Sites	137
Sustainable Construction	146
Accessibility for All	159
Understanding the Planning Process	166
Case Studies	170

Northumberland Coast AONB Design Guide for the Built Environment

Credits and Acknowledgments



NCC logo to be inserted

Funders

Production of the Design Guide has been supported by funding from Natural England, Northumberland County Council, Alnwick District Council and Berwick upon Tweed Borough Council.

Authors

Text, drawings and photographs prepared for the Northumberland Coast AONB Partnership by

Robin Dower and Tina Gough of Spence and Dower, Chartered Architects

in collaboration with

Mick Hall of Michael Hall, Chartered Landscape Architect

Images

The majority of the photographs and sketches were taken/drawn by the authors: Mick Hall, Robin Dower and Tina Gough.

Some of the photographs are reproduced from the AONB archive.

Many of the sketches by Robin Dower and Tina Gough have been reproduced from their work on the Design Guides of the North Pennines Area of Outstanding Natural Beauty and of the Northumberland National Park. Thanks go to these for permitting reproduction.

Credits for other photographs are set out under particular headings of the Design Guide Sections as follows:

Repair and Maintenance

- St. Mary's Church, Newton by the Sea. (*The Parish Plan and Design Statement of the Parish of Newton by the Sea*)
- Pinion's Barn, Northamptonshire. Architect: Simon Conder Associates. (*The Architects Journal: 9.02.06*)
- Showroom, Pfalz, Germany. Architect: Fischer Naumann Partnerschaft. (*The Architectural Review: Dec 2005*)

New Building

- Housing at Bridgend, River Tay, Perth. Architects: Parr Partnership. (*Tomorrow's Architectural Heritage by Fladmark, Mulvagh and Evans*)
- House at Mains of Branshogle. Architects: Simpson and Brown (*30% New House Design in Small Towns and Rural Areas, Architecture+DesignScotland*)
- Two bedroom house for rent at the Gleneagles Hotel (*Hotel brochure*)
- Fetternear. Architects: Michael Gilmour Associates. (*30% New House Design in Small Towns and Rural Areas, Architecture+DesignScotland*)
- Lotte Glob House, Scotland. Architect: Gokay Deveci. (*The Architect's Journal 6.10.05*)
- Alnwick Garden Visitor Centre. Architects: Hopkins Architects. (*The Architects Journal Awards Publication July 2006*)
- The Jerwood Centre, Grasmere, Cumbria. Architects: Benson and Forsyth/Napper Architects. (*The Architects Journal 23.06.05*)
- Chummy's Seafood Stall. Architects: Bond Architects. (*Shifting Sands by English Heritage and Commission for Architecture and the Built Environment*)

Reference List

Local and regional planning policy and guidance

Alnwick District Council (1997) **Alnwick District Wide Local Plan** Alnwick District Council
The local plan is currently being replaced by a Local Development Framework. Latest information can be obtained from www.alnwick.gov.uk or call 01665 510505

Berwick-upon-Tweed Borough Council (1999) **Berwick-upon-Tweed Borough Local Plan**
Berwick-upon-Tweed Borough
The local plan is currently being replaced by a Local Development Framework. Latest information can be obtained from www.berwickonline.org.uk or call 01289 330044

North East Regional Assembly (2005) **Regional Spatial Strategy** Submission draft North East Regional Assembly
Further details on finalisation of the regional Spatial Strategy are available from www.northeastassembly.gov.uk or Tel. 0845 673 3343

Northumberland Coast AONB Partnership (2004) **Northumberland Coast AONB Management Plan 2004-2009** Northumberland Coast AONB Partnership
Available at www.northumberlandcoastaonb.org.uk or call 01670 533000

Northumberland County Council (2005) **Northumberland County and National Park Joint Structure Plan** Northumberland County Council

Supplementary planning documents and guidance

Berwick-upon-Tweed Borough has the following supplementary planning guidance, also available from www.berwickonline.org.uk or call 01289 330044. Further supplementary planning documents may be developed as part of the Local Development Framework.

New agricultural buildings

Residential extensions / alterations

Rural buildings conversions

Shop front in conservation areas

Alnwick District Council has a schedule of supplementary planning documents planned as part of the Local Development Framework, as follows (call 01665 510505 for more information):

Residential Extensions (for 2008)

Layout and Design of Residential Developments (for 2008)

Energy Efficiency & Sustainable Development (for 2008)

Affordable Housing (2008)

Agricultural Buildings (for 2008)

Design Concept Statements as required for significant development sites (for 2009)

Conservation Area Management Plans and Character Appraisals

Berwick upon Tweed Borough (available from www.berwickonline.org.uk or call 01289 330044):

Berwick Conservation Area Character Appraisal and Management Plan (2006)

Tweedmouth Conservation Area Character Appraisal and Management Plan (2006)

Spittal Conservation Area Character Appraisal and Management Plan (2006)

Seahouses Conservation Area Character Appraisal (2006)

North Sunderland Conservation Area Character Appraisal (2006)

Alnwick District Council (available from www.alnwick.gov.uk or call 01665 510505):

Lesbury Conservation Area Character Appraisal (2006)

Alnmouth Conservation Area Character Appraisal (2006)

Warkworth Conservation Area Character Appraisal (2006)

National planning guidance

The Department for Communities and Local Government produces and distributes national planning guidance in the form of (new) Planning Policy Statements and (older) Planning Policy guidance. Various topics are relevant, including:

PPS1: Delivering Sustainable Development

PPS7: Sustainable Development in Rural Areas

PPS9: Biodiversity and Geological Conservation

PPG15: Planning and the Historic Environment

PPG20: Coastal Planning

Other relevant advice includes:

ODPM (2004) **Planning guidance and advice: lighting in the countryside – towards better practice**

All the above national advice can be accessed via www.communities.gov.uk, or call 020 7944 4400

Parish plans and design statements

Holy Island Parish Plan (2005) Holy Island Parish Council

Bamburgh Parish Plan (2005) Bamburgh Parish Council

Beadnell Village Plan (2000)

Replacement Parish-wide plan in progress as of 2007

The Parish Plan and Design Statement of the Parish of Newton by the Sea (2005)
Newton by the Sea Parish Council

Glossary

A Atrium

Historically a courtyard within a house offering privacy and open air as well as lighting to inner rooms. Now often refers to the glass covered space at the centre of large buildings such as hotels or offices.

B Brownfield Site

Planning term for a development site that has had previous development on it, including redundant industrial use (see Greenfield site).

Biomass

Living organism, usually timber or agricultural waste used as a fuel or energy source.

Bargeboards (or verge boards)

Timber forming gable edge to sloping roofs often elaborately decorated.

C Conservation Area

An area of town or village with high historic or architectural interest designated by local planning authority to confer a greater degree of protection under planning law.

Casements

The hinged opening components of windows usually side or top hung.

Chamfer

Sharp edge of stone or wood finished at 45° to reduce risk of damage. The chamfer is often stopped before a joint or corner.

D Dovecote

A building or part of a building set apart for pigeons; traditionally an important part of the mixed farm economy of the 18th and 19th centuries.

E Embodied energy

The total energy used in the production and transport of a given product or material.

F Fenestration

The design and provision of windows in a building.

G Greenfield Site

Planning term for a development site on which no previous development has occurred.

Green Roof

Roof construction designed to be finished with a depth of top soil or growing medium for plants (turf or sedum) acting as thermal insulation.

Gablets

Little gables.

Grey water

Rainwater or recycled washing water stored for use in irrigation and flushing WC's.

H Harling

A form of exterior finish widely used in Scotland and North England in which a mixture of an aggregate (small pebbles) and a binding material (traditionally sand and lime) is dashed onto a masonry wall. 'Wet Dash' incorporates the aggregate in the mix: in 'Dry Dash' the clean aggregate is thrown at the binding material separately.

Hemmel

Northern and Scottish term for farm implement shed usually with arched openings.

Horns

In the 19th century sash window the extension of the sides of the sash beyond the mid-rail: claimed to increase the strength of the joint: often decorative.

J Jambs

The vertical sides of a window or door opening which support the lintel.

K Kneeler

The bottom stone each side of a gable slope which resist the tendency of the tabling or sloping stones to slide off.

L Listed Building

Building Listed by Planning Authority and protected by Planning law for its architectural or historic interest or its group value.

M Mansard roof

A pitched roof of French origin having a double slope, the lower being steeper and usually longer than the upper allowing more roof space than a simple pitched roof.

Mitred joint

The junction of two components meeting at right angles by means of a 45° cut to each.

O Oriel window

A projecting upper floor window, often with a window seat, with views along the frontage of a building.

Q Quoins

French for corner – often used to refer to the individual stones forming the corner in masonry.

R Render

A term used to describe any durable protective coating to an external wall.

Re-pointing

The raking out and replacement of weathered mortar in the joints between stone or brickwork.

Random Rubble

Masonry walls in which the faces are formed in random sized stones not sharply dressed or squared. Coursed Rubble is set out with level beds.

S Snecked stonework

Dressed stone of different sizes laid out in interrupted courses of variable height.

Sash window

Window with sliding components (either vertical, counterbalanced by weights or springs, or horizontal, which tend to stick). Well established as the Conservation Officers' window of choice.

T Thermal mass

Construction in which a large mass (stonework or concrete) is used to store energy passively received from the sun or from a heating system and slowly release it over a period of time.

V Vernacular

Building forms arising from the application of traditional skills on locally available materials in the context of local conditions leading to character distinct to the area.

Northumberland Coast AONB Design Guide for the Built Environment

Introduction



The Northumberland Coast AONB covers an area of 53 square miles along 40 miles of coastline from Warkworth to Berwick upon Tweed. This narrow sliver of countryside, never more than a mile and a half wide, contains some of the most dramatic coastal scenery in the country; sweeping sandy beaches backed by deep sand dunes, high rocky cliffs and islands – and behind it all, the long-cultivated and rich farmland of the coastal plain.

The coast is studded with numerous small settlements established on the opportunity of fishing, mineral working or coastal trade. These traditional industries have declined in importance but development pressures grow with the popularity of the coast for retirement and tourism. The population of 10,000 is sharply swollen in summer months by visitors.



Northumberland County and Alnwick District and Berwick-upon-Tweed Borough Councils have a duty to protect and enhance the natural beauty and cultural heritage of the Northumberland Coast Area of Outstanding Natural Beauty, which was designated in 1958 under the provisions of the National Parks and Access to the Countryside Act 1949. It is one of 37 such areas in England representing, together with the National Parks, the nationally recognised quality of our finest landscapes.

The Countryside and Rights of Way Act 2000 created AONB Partnerships (Local Authorities, Natural England, representatives of local communities and other stakeholders) and required the preparation of a Management Plan for each AONB. This was to provide the means for conserving and enhancing the landscape of the AONB for the future benefit of the environment, community, visitors and future generations. The Northumberland Coast AONB Management Plan was published in 2004.

It is Management Plan policy to “improve the quality of design in new buildings, alterations and maintenance work and in materials and skills employed through the provision of advice and design guidance”: (Policy LP5)

The Design Guide implements the policies developed in the Management Plan in which good design and building conservation were identified as high priorities by consultees on the Plan. These were also acknowledged as being key issues during public consultation for this Design Guide. In order to conserve the diversity and distinctiveness of the coastal environment, inappropriate development should be resisted. It is equally important to ensure that both new development and alterations or extension of existing buildings are of suitable scale, well designed and relate well to the coastal landscape setting.

Higher standards can be achieved by co-operation between developers, architects, builders and local authorities supported by AONB Partnership Guidance to supplement emerging Local Development Framework policies. The aim of the Design Guide is to raise awareness of good design and to suggest criteria and practice which will protect and enhance the distinctive character of this cherished landscape. It is intended that the Design Guide should supplement local authority land use planning documents.



User Guide

The Design Guide contains a lot of information and is a large document, but the following suggestions should help you find your way around the structure and seek out the guidance on design that is most relevant and interesting to you. There is some repetition of subject matter between sections. This is deliberate in order that each section can easily be used independently without having to cross reference to another section. For example, the subject of inserting rooflights occurs in both 'Conversions' and 'Alterations and Extensions'.

It is intended that everyone reading the Design Guide should obtain some background information to design within the AONB by reading **The Need for Design Guidance** and **Design Criteria** no matter which part of the remainder of the Guide is of particular interest to that individual. The sections **Sustainable Construction** and **Accessibility for All** are also appropriate considerations which any developer will need to address.

Other sections are set out on the principles of building work met within the AONB.

Repair and Maintenance
Alterations and Extensions
Conversions

New Building
Landscape, Planting and External Detail
Caravan, Chalet and Camping Sites

Each of these contains information on the design detailing, materials and setting relevant to a particular project.

Some settlements have separate design documents and it is recommended that anyone considering development should look at the one which is applicable. They are included in the Reference List.

Understanding the Planning Process sets out the requirements of the AONB and the process of making an application for Planning Permission, Listed Building Consent and related applications

How to Use the Guide

Step 1

Read **The Need for Design Guidance** and **Design Criteria**
 Also where relevant link to individual settlement documents

Step 2

Consider the type of development proposed and choose the category of the guide that is most relevant

Step 3

Refer to the information contained within **Sustainable Construction** and **Accessibility for All**

Step 4

Produce sketch design proposals for informal consultation with the development control team of your District Council

Step 5

Submit planning and other related applications where applicable
 See **Understanding the Planning Process**

Northumberland Coast AONB Design Guide for the Built Environment

The Need for Design Guidance



There are many pressures for change and development in the built environment and many reasons for contemporary designers to consider ways of responding which move forward from the limited scope of traditional building, form and technology.

While part of the Design Guide focuses on protecting the fabric and character of traditional buildings in the AONB this alone does not encompass all the possibilities of today's technology or provide appropriate space for contemporary uses and economic activity.



In pursuing the primary purpose of designation of the AONB local authorities must take into account the well being of the economic and social framework of local communities and will seek to promote sustainable forms of development that in themselves protect and enhance the natural beauty of the environment.

The local economy depends increasingly on tourism stimulated by the rich diversity of coastal landscape and the distinctive identity of the settlements in it. The direction of development should be steered towards maintaining local identity against the trends that dilute it.

During the 20th century the individuality of coastal settlements and traditional building styles has been compromised. Some settlements have expanded rapidly beyond established boundaries: and building styles, materials and technology have developed beyond the scope of local traditions. Also, many small scale alterations and maintenance takes place without the need for planning permission and are difficult to influence. The individual and cumulative impact can lead, and in some settlements has already led, to loss of character.



In this short terrace five different window types can be seen and three styles of door; changes to windows and doors have disturbed the unity and harmony of the original

Great changes have been taking place in the home. Household sizes are decreasing, but there is a steady demand for more space. Technological developments in telecommunications now suggest a greater number of residents working from home requiring changes in arrangement of space. Leisure in the home also generates an enthusiasm for conservatories, workshop extensions and playrooms. Kitchens and bathrooms are reworked on average every fifteen to twenty years.

Householders who wish to ensure that their property is energy efficient will examine new methods of controlling heat input and preventing heat loss. Very often changes to windows and doors seem to be considered essential to reduce draughts. Solar and photovoltaic panels may appear on south facing sloping roofs, and other forms of renewable energy technology will become available.

Photovoltaic panel insertion into the roof of an old cottage



The Government's campaign to improve energy conservation through thermal insulation is only part of national and local government's influence on the design of buildings. Building Regulations, British Standards and Technical Guidelines cover all aspects of construction. Designers and the building industry must operate within statutory regulations affecting access for the disabled, safety standards and structural stability amongst many other matters.

The building industry too has undergone major changes in the organisation of trades, in construction methods and in procurement of materials and components. Neither the domestic market in home alterations (backed by a powerful "home maker" and DIY advertising sector) nor the nationwide building materials distribution network are at all sensitive to issues of local character or distinctiveness.

Changes in farm practice and land management lead to new forms and scale of farm buildings for in-wintering sheep and cattle, indoor lambing and calving, for storage of feed and larger machinery. If the traditional farm buildings become redundant their future can sometimes be secured by conversion to a suitable new use, often residential or holiday accommodation for which there is a growing demand.



It is against this background of change in demand and supply that the case for design guidance is widely accepted. Britain's rich regional diversity of character could be (has in some ways already been) eroded by the strengths of the national economy, by improved communication and transport systems and by the competitive advantage which mass production brings.

What the publication of this Design Guide is intended to achieve is to excite an interest in what it is that makes for local distinctiveness, that tells us we are here in Northumberland rather than on the Cornish Coast, and to challenge developers to think about how they might match that character in tomorrow's heritage which they are building today. By a wider debate about good design within the AONB we also hope to influence the way minor alterations, which may not require planning consent, are carried out.

The Design Guide seeks to promote development that is good-mannered towards its neighbours and belongs comfortably in its setting. Such development is unlikely to be opposed and developers will find that the higher quality end product will have a financial benefit in the improved market appeal of new buildings which truly adorn their setting. From the Local Authorities' viewpoint the Local Development Framework policies and Design Guide together will encourage a greater consistency of approach to applications and enable us to share our objectives with communities in the AONB and thus further the protection and enhancement of its natural and cultural heritage.

“With proper understanding of the historic environment, clarity of purpose and sensitivity to the quality of place, excellent new build and design will both complement and enhance the historic environment”

“A sense of continuity does not have to stop new ideas – just the opposite”

“Good new design will create a rich historic environment for the future”

English Heritage – Power of Place, 2003



Northumberland Coast AONB Design Guide for the Built Environment

The Character of the AONB

Natural Beauty and Cultural Heritage



What do we mean by “Natural beauty”?

In this heavily populated island landscapes are not isolated primordial wilderness but reflect the impact of human activity over several thousand years. Our appreciation of natural beauty is a complex response to landform and geology, landscape features, the habitat of animals and plants and above all to the rich history of human settlement over time: a reflection of cultural and social structures from the past carried forward and modified as they are today ... and might become in the future.



The character of settlements and buildings in the AONB derives historically from an intimate human response to the varied geology and topography of the coastline, conditions of exposure or shelter, the landscape setting and to both historical and more recent economic opportunities afforded by the use of land and the materials locally available from it. Always present has been the influence of the sea, on which the livelihood of the fishing industry depended of course, but which was also a busy thoroughfare transporting raw materials and finished products of farm, mine and quarry from medieval times to the early 20th Century (now largely superseded in the face of road and rail transport systems).



While economic activity directly related to the land continues, much of the traditional industrial base has changed, even disappeared. What seems to be happening is a loosening of the traditional association between landform, geology, ecology and human activity with contemporary pressures of use and development tending to result in a dilution of local distinctiveness. However, the environmental wealth and landscape quality of the AONB has led to a shift towards tourism and holiday making which has supplanted the older industries as the chief economic activity of the settlements alongside farming in the rural hinterland.

The history of defence is written on this coast too from the concrete anti-tank blocks along Fenham flats and the war-time airfield at Boulmer back through the centuries to Bamburgh, Warkworth and Dunstanburgh Castles: this last owned by John of Gaunt, Earl of Lancaster, to whom Shakespeare gave memorable death-bed lines on England's defences.



This fortress built by Nature for herself...

*This precious stone set in the silver sea
Which serves it in the office of a wall
Or as a moat defensive to a house...*

*Whose rocky shore beats back the envious siege
Of watery Neptune.*

Watery Neptune, without human intervention, has nevertheless shaped the coastline and the varied geology has resisted or given way to the onslaught, creating the diverse character of landscape of "this other Eden, demi-paradise."

The Character of Landscape and Settlement in the AONB



A key feature of the Northumberland Coast is the contrast between what are predominantly compact, tightly knit settlements and the large scale, open, coastal scenery which surrounds them. Both the villages and the wider landscape possess sufficient variation in geology, topography and history to give each area a locally distinctive character. At the same time, the AONB landscape of today is a product of a response to recurring factors which are common to the whole area; an overall sense of unity stems from such issues as the basic desire for shelter (or sea views) and the prevailing effect of maritime exposure on plant growth and animal husbandry, shaping farm practice.

Landscape Character

The Northumberland Coast Landscape comprises six distinctive local character areas within the AONB and in some cases can also be divided into sub-zones or transitional areas - these often reflect variations in local geology. The main local character areas are:

1. Spittal to Saltpan Rocks
2. Saltpan Rocks to Budle Point
3. The Farne Islands
4. Budle Point to Castle Point
5. Castle Point to Seaton Point
6. Seaton Point to Coquet Estuary

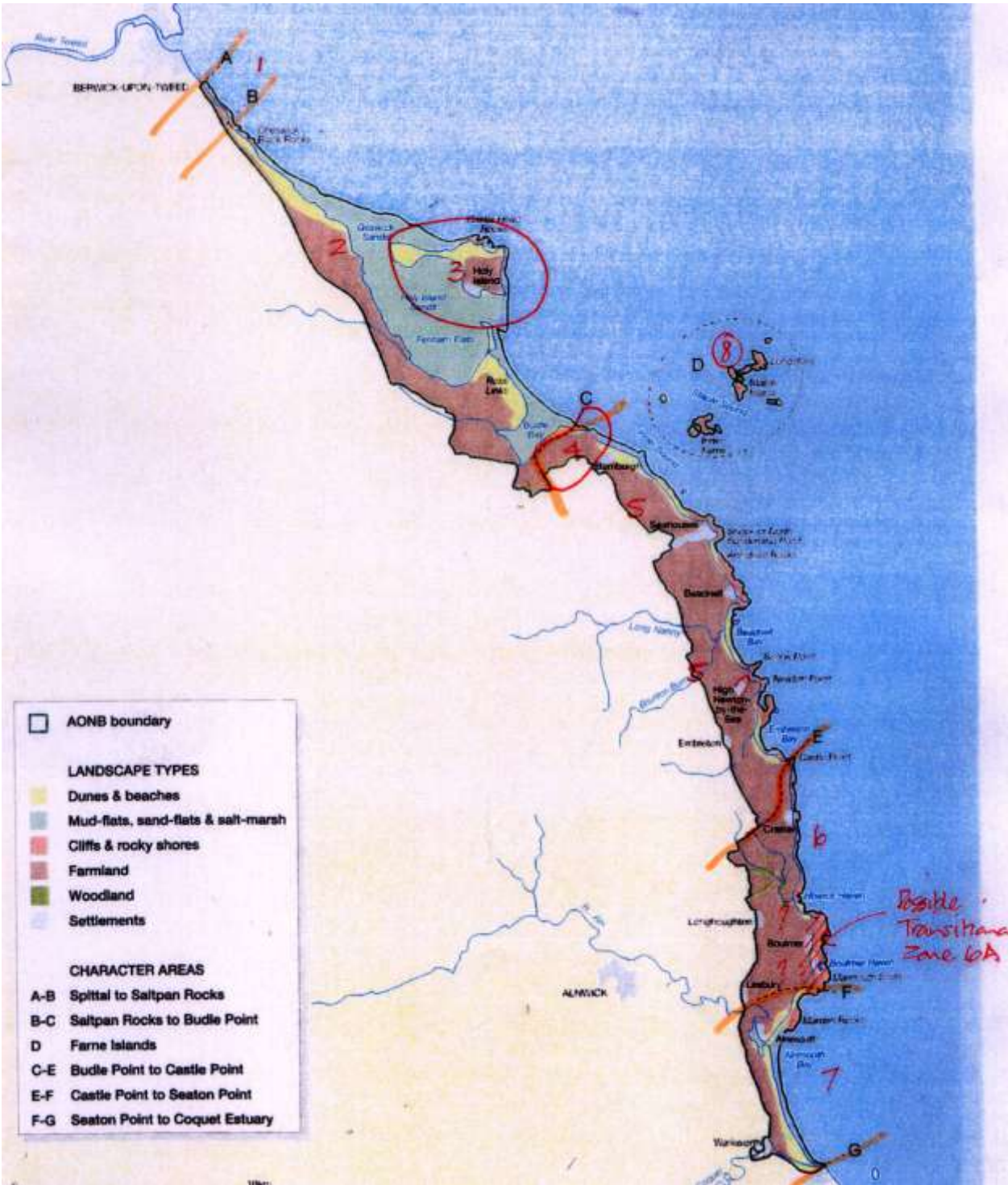

Map to be reproduced to better standard

Areas of Local Landscape Character - North to South

1. Spittal to Saltpan Rocks

A narrow strip of farmland with dramatic cliffs. The visual boundary lies outside the AONB on the ridge top. The western skyline is punctuated by a series of isolated farmsteads and terminates at the northern end at Spittal where a poorly screened caravan site and social housing form a suburban visual intrusion into the scene.

2. Saltpan Rocks to Budle Point

This is a landscape of generally open low-lying farmland forming the distinctive setting for Holy Island. In the north the coastal dune systems are interrupted by a series of rocky headlands. Inland, scattered farmsteads, often located on hilltops, and shelterbelts form the main landscape features. Further south the coastline becomes more open and exposed with the tidal zone becoming more dominant. Shelterbelt planting becomes more prominent and hedgerows are generally limited in range and quality owing to the high level of exposure to saline winds. In many areas wire fences form the main field boundaries and hedgerow trees are rare.



Holy Island subsection - Within this broad landscape context Holy Island retains a strongly individual character and can be regarded as a sub-zone. The horizontal emphasis of the surrounding landscape is interrupted by Lindisfarne Castle, situated on a prominent whinstone dyke and to a lesser extent by the eastern extension of the same dyke which shelters the village.

3. The Farne Islands

An offshore outcrop of the whinstone geology, a group of islands of varying size and height and of international importance as a sea bird habitat and cultural significance as the one time retreat of St. Cuthbert. Most of the islands are bare cliff with thin soil tops of grass and campion. Only on the Inner Farne and Brownsman has any attempt at cultivation been made by occupants of the lighthouses.

4. Budle Point to Castle Point

This area of the AONB can be sub-divided into 3 sections, the two northern sections meeting at Bamburgh Castle and the southern sub-zone lying to the south of Beadnell.

Budle Point Headland - Budle Point lies on the prominent headland which forms a distinct southern end to the sweeping coastal landscape to the north (the precise boundary of this zone hugs the coastline west from the Point and follows the Waren Burn south from the coast). The steeper slopes and high ground reflect the underlying whinstone geology (this area constitutes the largest and northernmost area of the whin sill in the AONB). There are few buildings on the headland; two of the established caravan sites are not visible from main roads owing to the nature of the topography. Bamburgh Castle is located on the eastern end of the whinstone outcrop.



Bamburgh to Beadnell - This area offers two contrasting landscapes; the wild sand dune scenery of the coastal strip east of the road linking the two communities and the farmed landscape to the west. The inland landscape reflects the greater variation in soils which creates a diverse pattern of fields and isolated farmsteads. Hedgerows and hedgerow trees become a more significant feature.



Beadnell to Castle Point - In this section of the AONB the sandy bays (formed where the softer underlying shales have been eroded away) bite deeper into the inland areas. Small areas of whinstone provide variety near Newton by the Sea. Here the coastal landscape and the inland farmland are more in harmony, with intimate patterns of fields, hedgerows, roads and settlements creating a much softer landscape than that to the north.



5. Castle Point to Seaton Point

A rugged landscape compared to other sections of the coast. In places the inland farmland contains deeper river valleys and steeper slopes, with woodlands, hedgerows, and hedgerow trees creating a landscape of great variety.

Three sub-divisions are evident:

Castle Point to Howick - A landscape dominated by whinstone which creates coastal cliffs and near Craster the spectacular inland outcrops known as the Heughs. The whinstone also provides the bedrock for the rough acidic grassland which dominates the coastal strip. Inland, on richer soils, the landscape contains substantial farmsteads and numerous scattered shelterbelt plantations.



Howick Woodland & Estate - One small area of the AONB in which woodland dominates. Howick lies on a geological boundary which is partially concealed by the extensive estate planting. The wooded corridor of Howick Burn is a particularly significant feature.

Howick to Seaton Point - To the south of Howick the landscape reverts to the typical open landscape characteristic of limestone scenery, emphasised to some degree by the wartime RAF station. Scattered isolated farmsteadings, with attendant shelter planting predominate - field boundaries are post and wire fences with very occasional hedgerows. The coastal headland east of RAF Boulmer is of Millstone Grit.

6. Seaton Point to Coquet Estuary

A unified landscape zone with the coastal area dominated by sandy beaches and extensive sand dune systems with isolated rock outcrops. The inland landscape contains low lying floodplains and sinuous river valleys, which are of great natural diversity. The latter contain visually significant woodlands which link the settlements of Alnmouth and Warkworth into the surrounding landscape.

The Settlements

Within the Context of the wider Landscape Character of the AONB each settlement has a distinct identity. Many communities have already carefully recorded the history, character and potential of their settlements in the form of Village Appraisals and Parish Plans. There are a dozen settlements, described from North to South. Of these the following include **Conservation Areas** designated by the local authority:

Holy Island (the entire island above high water mark)
Bamburgh
Seahouses and North Sunderland

Lesbury
Alnmouth
Warkwort

The following brief descriptions in no way attempts the detail of the local community's appraisal of their own environment. A reference list of key documents is available in the Credits and Acknowledgements section of the Design Guide, and includes these Village Appraisals and Plans.

The settlements are described from North to South.

Holy Island

Seen from the mainland approach by Beal the village of Holy Island is an unobtrusive gathering of roofs visible as a horizontal splash of red amongst trees at the South tip of the island. Only the Castle stands out above it against the sea.

Crossing Holy Island Sands the road enters the village between stone field walls which gradually change into higher garden walls and hedges. Older buildings along the narrow streets are in whinstone with sandstone detailing to openings and quoins; Welsh slate and pantiles the main roof covering. A thrifty incorporation of recycled material into boundary walls and pavings (rough sea boulders, shells, bricks and tiles) seems to strengthen the island character.

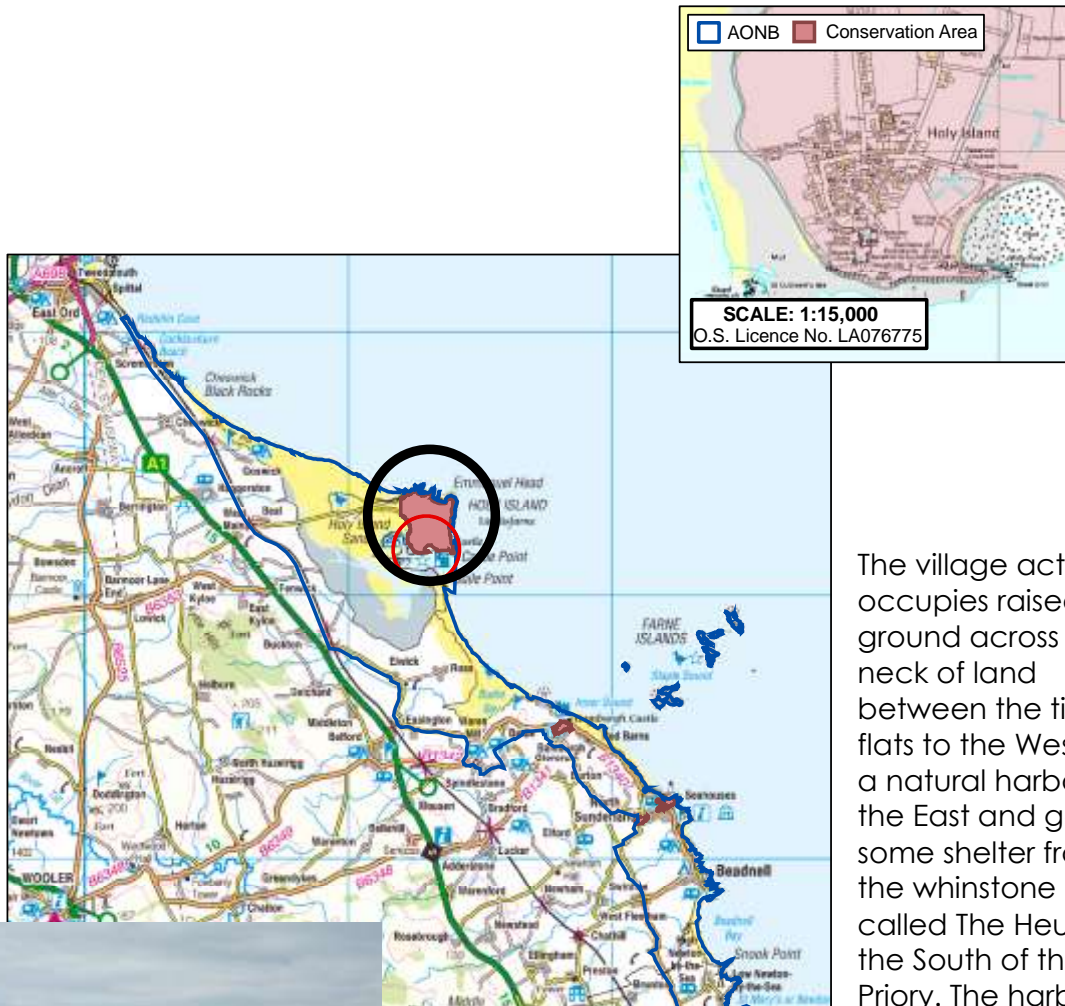

The village actually occupies raised ground across a neck of land between the tidal flats to the West and a natural harbour to the East and gains some shelter from the whinstone dyke called The Heugh to the South of the Priory. The harbour is silted up but a fine

group of buildings round a cobbled courtyard was formerly a smoke house and warehousing from the herring fishery days of the early 19th Century, now nicely converted into residential use.



The village seems to cope well with the pressure of tourism and maintains a good standard of shops, restaurants, museum, gardens and hostleries. With substantial car parking provided in fields to the North of the village the experience of Holy Island is attractive at walking pace.



The pantile and slate roofed vernacular of the village centre gives way to pebble-dashed bungalows with concrete tiled roofs round the West side.



Open grass areas in front of these are much used for parking cars. In some areas short stubs of timber are placed to protect lawns seeming to confuse public and private status.



There are quite a number of mature trees in the village centre, mainly sycamore with fine canopies established in the shelter of high walls. At the edge of the settlement, more difficult for vegetation but walls and banks serve for shelter, some delightfully covered with wallflowers and valerian.

Views out from key points within the village emphasise the contrast between the compact sheltered village and the open landscape which surrounds it.

Beal

Worth pointing out amongst other farmsteads in the AONB as being particularly conspicuous on the skyline as a group of solid stone buildings with pantile roofs backed by mature trees. A big house on the North side of the road with high walled garden and farmstead on the South, redundant buildings to the East converted to holiday cottages. The composition is interesting for its compactness and its prominence in the large flat landscape surrounding it. Large modern sheds at the North side of the farmhouse are still within the cluster.



Budle Bay / Waren Mill

The fine tall Flour Mill at the head of Budle Bay stood empty for many years, now converted into flats, a major development project with difficult planning implications relating to vehicular access, related site development, retention of the industrial character, intrusion on the adjacent National Nature Reserve. Within the little valley of the Waren Burn further stone buildings with mature trees and a caravan park well hidden behind.



Bamburgh



The village is dominated by the Castle which stands removed and aloof on the whin sill partly screening the village green from the sea.



As the centre of Royal Saxon Northumbria the village also became the focus for the Christian conversion of the kingdom under St. Aidan introduced by King Oswald. There remains, not only in the Church (one of the finest parish churches in the Diocese) but in archaeological evidence in Bamburgh Hall and Friary Farm, evidence of the continued influence of the Church throughout the Middle Ages.

Bamburgh does not feature much in the record of local industry along the AONB coastline. The fact is that the village does not have a viable harbour and would not have been able to compete with other villages better provided with natural or at least potential harbours. So Bamburgh is distinct in this way. Did it also regard itself as being rather above industry? There is an air of quality about the place: good buildings, well kept open space and cricket on the village green.



The main street from the Castle forks within the village to create a generous open space occupied by a stand of mature sycamore trees full of rooks nests. These provide a sort of umbrella over the frontages onto the village centre where shops, hotels and private cottages are generally well built and well conserved.



Generally much effort has been made both by owners and the planning authority to maintain Bamburgh's distinct character and it is undoubtedly a popular tourist attraction. The influence of a later owner of Bamburgh Castle, Lord Armstrong, can be seen in the attractive estate of painted timber clad houses off the road down to Seahouses.



North Sunderland and Seahouses

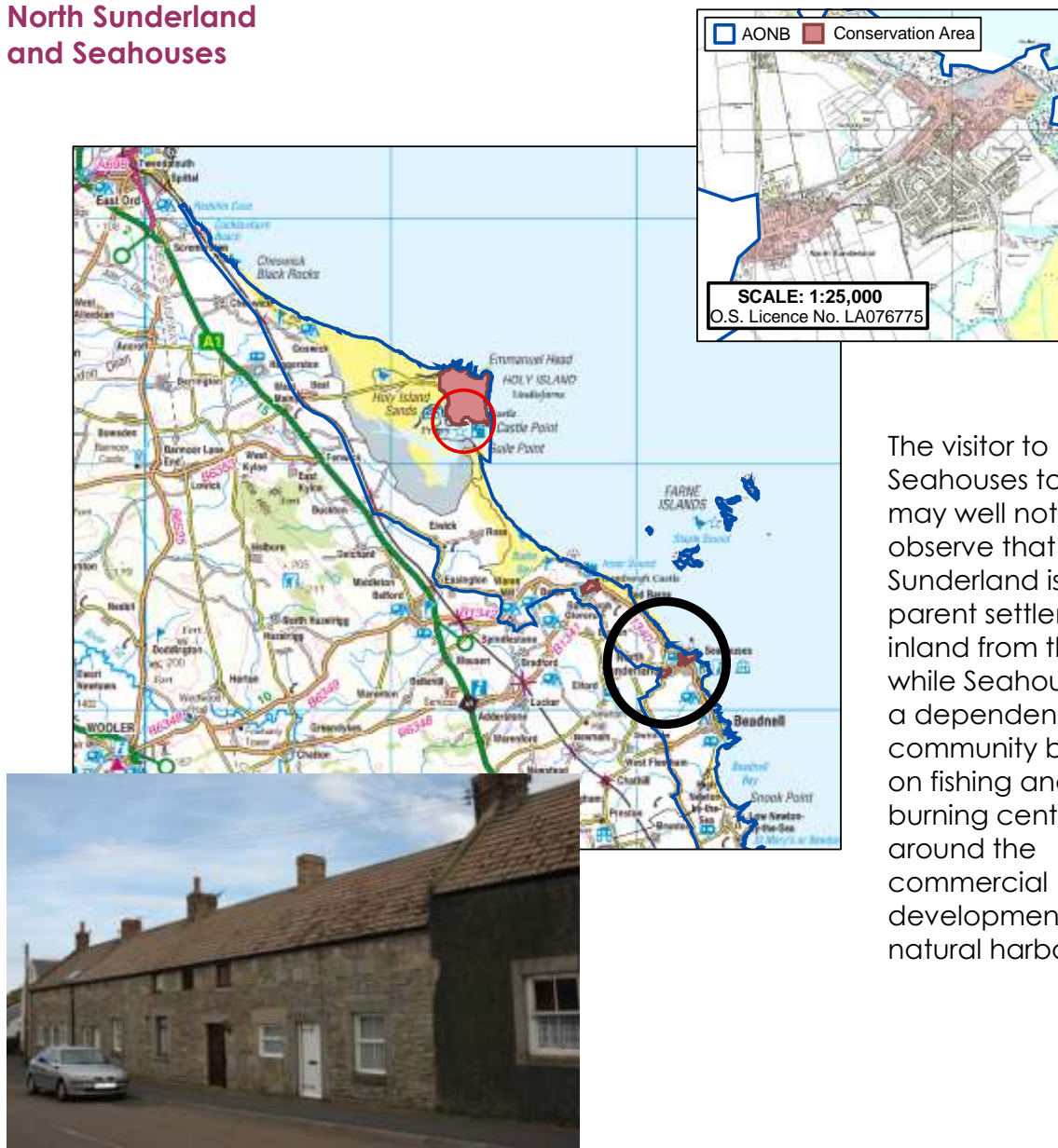

The visitor to Seahouses today may well not observe that North Sunderland is the parent settlement inland from the sea while Seahouses was a dependent community based on fishing and lime burning centred around the commercial development of the natural harbour.

North Sunderland related to its agricultural hinterland with a number of granaries built in the 18th Century along the main street – now converted to other uses. But fine houses with high walled gardens show that this end of the parish had the upper hand in quality.



Seahouses benefited from the collapse of Alnmouth as a commercial port after 1806 and was thriving in the first half of the 19th Century through to the early years of the 20th. Much evidence still exists: the vestiges of the railway line to the harbour can still be seen in the car park next to the caravan site, limekilns above the harbour now used as fishermen's stores, granaries and warehouses, many converted for tourist purposes. But the centre of the village has been rather overwhelmed by tourist trade – a cheerful anarchy of restaurants, pubs, amusement arcades, shops and the clutter of uncoordinated street furniture. Coach loads of trippers, caravaners all seeking entertainment in fair weather or foul seem to congregate here, close to the harbour with its colourful boats and sea smells.



Just a little to the South older harbour and fishermen's houses in South Street and Craster Square have retained their undisturbed dignity; to the North along the front road leading to Bamburgh quite grand terraced and semi-detached housing with tiled roofs and brick or rendered walls. On the inland road from the North end of the village back to North Sunderland new development begins to occupy the triangle within the road network. On the South side of the road between Seahouses and North Sunderland a large post-war estate shows no particular local characteristics – developers' designs in brick, render and a wide palette of roofing materials.



Beadnell

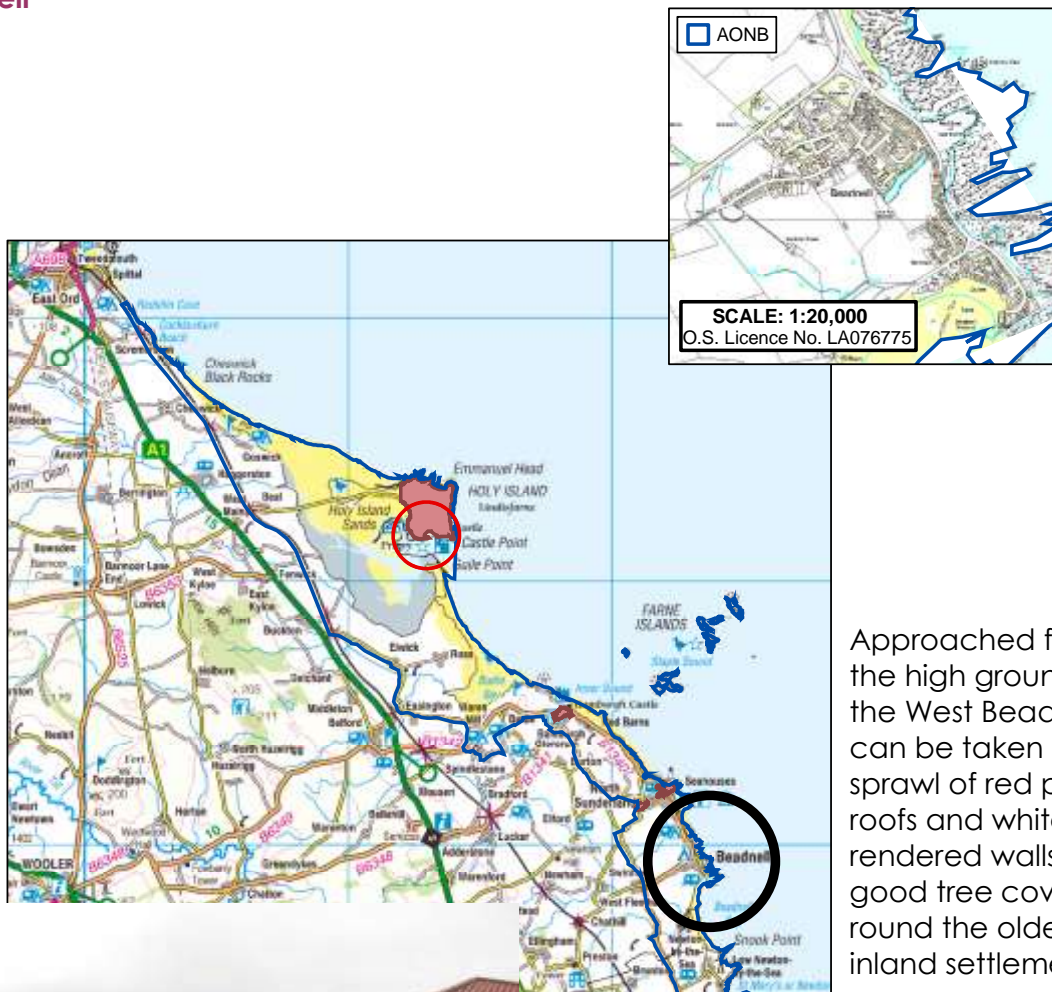

Approached from the high ground to the West Beadnell can be taken as a sprawl of red pantile roofs and white rendered walls with good tree cover only round the older inland settlement.



Old Beadnell with Beadnell Hall and St. Ebba's Church forming a square with other older buildings is set back from the sea and sheltered by high walls and mature trees. Post-war bungalows to the East form a link with the sea frontage; the road down to the Harbour, consists of a sprawl of small nondescript 1930's and later villas and Swiss chalet style holiday homes which express their individuality in alterations and extensions of every conceivable form (sunrooms, balconies, porches, dormers, picture windows) and a wide range of materials (heavy timber, light timber, metals, glass, uPVC frames). Given the exposure to the open sea few owners attempt gardening and most front areas are given over to hardstanding for cars or boats. A very high proportion of Beadnell's housing is second home and holiday letting.

Behind this motley frontage lies a newly developed estate of permanent homes a little sheltered by the profile of land created by the underlying limestone shelf. An old limestone quarry fenced off for safety interrupts the development at the South end of this estate.



At the harbour end of the road lies a terrace of older cottages (fishermen and harbour workers) Benthall – a low row with stone walls round back yards giving onto a drying green with a couple of old boat winches.



The point is dominated by a white rendered flat roofed property in 1930's maritime style; another similar more interesting house lies behind the lime kilns (with a curved front and an attached garage with a roof extended forward to shelter the front door).

Some of the houses near the harbour have interesting hard landscape surfaces; small sea-worn cobbles, old bricks, granite sets, In this more densely built area, somewhat sheltered by the limekilns and the ramp, some attractive gardens are flourishing.

Camping and caravan parks have been established at Beadnell for many years. Little attempt has been made to disguise these and, given the exposure of Beadnell Bay planting would certainly be slow to achieve screening.

Newton-by-the Sea

High Newton lacks obvious coherence even round the village green. The Hall (thought to be by William Newton of Newcastle) late 18th century, and Newton House, together with a few other older houses with painted rendered walls and dormer windows, are interspersed with more recent bungalows.

A little North of here Newtonbarns and Tughall farmsteads have been converted to holiday letting units. These are typical large late 18th up to mid 19th century estate farm buildings, a type in which Northumberland led the way.

Low Newton (or Newton Seahouses)



Fishermen's cottages forming three sides of a square facing out to sea, well preserved by the National Trust. Consistent detailing in original dormer windows rising in stone off the front wall with pedimented gable and pitched roof.

Simple lean-to porch to each cottage, lower windows in dressed stone surround with long central jambstones.. All the merits of unified design illustrated here.

Further up behind the square to the North a new terrace of 'upmarket' housing, whilst interesting, makes little reference to local character.



Between Low Newton and Embleton in the dunes is a long established colony of chalets, wooden huts with felt or slate roofs and well maintained and idiosyncratic flowerbeds and seats: devoted owners.

Embleton



The whole village here repeats the fundamental concept of shelter from the sea behind the first rising ground inland, and in spite of much 20th century addition has the feel of a long established settlement. The Church and Old Vicarage with an exquisite early curvilinear glass house are rather screened from the village by established trees.

Short terraces of housing and the Inn make a significant contribution and individual buildings too offer attraction; the idiosyncratic older house on the high ground to the East with pointed arch door and shouldered windows. At the South end windows of newish development on road out to Dunstan framed by heavy projecting render surrounds. Behind these the only mansard roof with heavy barge boards and steep hung slates with outward hip at bottom – rather Hansel and Gretel type – not local in feel.

Just West of this group another terrace with three different porches are an object lesson in failure to consider common character –

- One: simple porch as sheltered entrance
- Two: porch as garden room – overlarge and too high, though with pitched roof
- Three: flat roof with felt – a mean box



On the East side of Dunstan road three independent 'off-the-peg' garages take no notice of each other, while a garage courtyard behind the next house North is better coordinated.



Further North along the seaward ridge a small house has been extended with overbearing box dormers and conspicuously crude yellow tabling to the gables, a lapse of development control? Further North along the road to Beadnell is a new development of sheltered housing in a brick just a little too bright and brash.



The impact of the Whinstone Quarry closed in 1961 is much less obvious than Craster's but the quarry was worked for nearly a century and at its peak employed over 100 men; a significant local enterprise indeed.

Craster

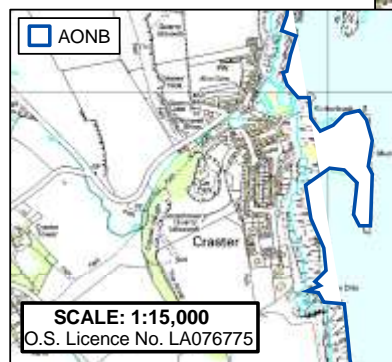

A small village in which whinstone predominates as building material, black, grey and brown. Just inland, and now forming well screened public car parking for this popular tourist spot, is the large abandoned whinstone quarry closed in 1939. One can therefore assume that little post-war building was added in this material. Even with the whinstone, however, sandstone was brought in for dressed work around openings and at quoins. In many buildings the whinstone is built up in 450 – 600mm bands marked by distinct horizontal courses.



Render is widely used both on traditional buildings and on the social housing provision at the South end of the village, colour either natural cement tone or proprietary through-colour or applied as masonry paint. Windows and doors often have raised surrounds, some picked out in different colour.

Roofs, slate and pantiles mixed: dormer windows, many as part of original form of cottage but others added to effect loft conversions of all sorts and at different levels.

Facing the sea most properties have opted for uPVC windows, many imitating timber sash type right down to stick-on horns below the top sash, and stick on glazing bars.



Note the distinctive industrial character of the fish-smokery in the centre of the village; dark whinstone base to walls, dark stained timber upper walls and pantile roofs. The vents from the smoke chambers in dark timber louvres – all very coherent.

Garden walls in whinstone with different tops: large beach pebbles, concrete or left open for naturalised plants, valerian, wallflowers, toadflax or grass. A variety of wooden or metal gates.

In Craster as in other villages the terrace of cottages forms the consistent unit of building more than the individual house and in the terrace a common character is established and largely maintained. It is satisfying to see this tradition continued in the social housing to the south of the village. The few independent houses at the North end (in the field leading out of the village towards Dunstanburgh Castle) look uncomfortably isolated.



Extensive areas of young trees and shrubs at the entrance to the village demonstrate the opportunities for planting in the AONB and assist in linking new house building into the landscape.

Dunstan, inland from Craster, is of quite a different character, really only a street of detached and semi-detached houses and bungalows with well established gardens. Dunstan Hall at the North end is a striking mix of mediaeval, 18th century and good 20th century Arts and Crafts happily brought together.

Howick

Set within the woodland landscape of its own estate Howick Hall, the only major classical country house in the AONB, enjoys considerable privacy while offering public access, car parking and tea rooms.

Howick village relocated in the 1840's is beautifully sited to the East of the Hall but sheltered by the first high ground in from the coast, not seeking views of the sea. Field and garden walls hold the buildings into the landscape and trees, which also benefit from the sheltered environment, link the settlement to the wooded surrounds of the Hall.



The main feature of the village is a terrace of Tudor style estate labourers' cottages with central gabled tower, probably a dove-cote. To the West stands a converted 19th Century school with bellcote and large projecting chimney. Paint to external joinery is a distinct cream colour going well with the stone.

Longhoughton



Another long village of large older properties mixed both with stone built terrace cottages and with 20th Century rendered housing, much for personnel based at Boulmer RAF Station. Importance of trees in the street – large sycamore – and extent of cover in older private gardens. Towards the newer North end the selection of planting is less confident in scale – ornamentals that will never grow large.

A clumsy elephantine bus-shelter outside the local store (former NAAFI) offers little protected space for all its stone structure.

Off the East side of Main Street a small terrace of Sheltered Housing with a rather harsh snekked stone outer shell and garden walls, but facing East a kinder brick with attractive porches/stores and pitched roofs running back into the main roof slopes. The contrast of this well detailed modest development with the adjacent "Tarn Breeze" estate (shown in photograph above) by a local developer is sharp. Here 'off-the-peg' designs have been dropped round a 'green' with little subtlety and no regard for local distinctiveness. The trees selected for the 'green' are not flourishing since Lime is not tolerant of maritime conditions.



Boulmer

A very small hamlet redolent of sea smells, lobster pots and valerian.

A range of low houses just behind the sea front battened down and almost aerodynamic in profile with sheltered gardens on the inland side facing the road. Later attempts to turn towards the sea have resulted in a few rather poorly designed porches. The pub has a timber deck beer garden fully exposed. At the North end of the cottages a timber shed with felt roof against a stone shed with pantiles and a corrugated barrel roof shed (Nissen hut) suggest some interesting diversity of form that could be reinvented in contemporary minor and subsidiary buildings.

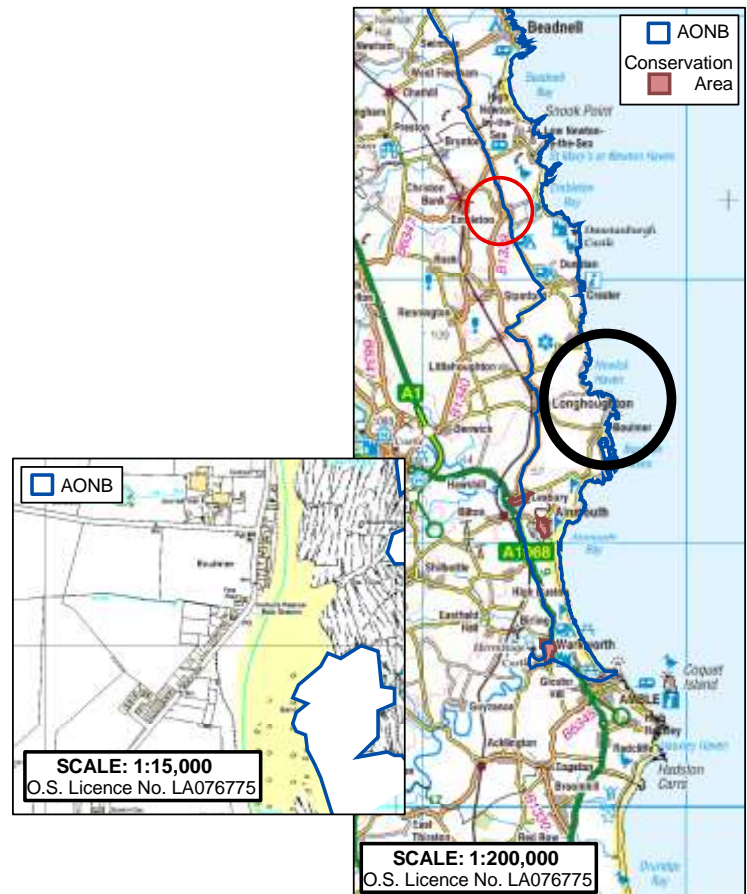

Boulmer Hall Farm inland at the North end with bright yellow lichen on slate roofs. The walls around the farm help to bind the buildings into the landscape as do the trees behind them.

Lesbury



An old village strung out beneath mature trees, a mixture of terrace cottages and detached houses in stone, mainly slate roofs. One past owner in a modest terrace of cottages has changed slate roof covering for concrete tiles: a poor decision since scale and thickness of tiles has broken the unity of the original terrace.

Small details matter: the Post Office still has a good original battened and ribbed door. A matching door remains in the other half of the building but is now hidden by a later porch.

New development tends to happen in the back-lands both sides of the main street. The new 'Alnside Estate' of fine ashlar houses in classical idiom and plenty of space (see photograph above) is approached by a cul de sac drive finished with large red granite chippings rolled in. Garden walls in brick with rounded stone copings, and ornamental trees too small for the scale of development. At the West end a nicely detailed sun room follows the roof line of the single storey wing. This estate is slightly self-conscious in its classical clothes but not unsuitable in the village which is much influenced by the Northumberland Estates.



Alnmouth

The approach from the West through Hipsburn and across the River Aln gives a clear reading of the way the village grew along the sheltered slope of the spur with mediaeval burgage plots running down the slope from Northumberland Street towards the estuary. Only at the very far end does the village emerge from the lee of the high ground to take advantage, in the way the later 19th century was disposed to do, of the excellent views Southwards and out to sea. Later development turned the corner along the outer side of the spur and along its ridge offering interesting examples of changing attitudes.

The commercial mercantile development of the port, once the busiest on the coast, came to an abrupt end with a disastrous storm in 1806 which broke through the isthmus that protected the harbour. Thereafter Alnmouth rapidly lost ground to Seahouses, Amble and Berwick.

The old warehouses and granaries have been converted to other uses but it is from their commercial origins that we can recognise that the scale of Alnmouth's development is larger, bulkier than most villages would show. Subsequent additions of large late nineteenth century villas with elaborate bargeboards, balconies, bay windows and oriel windows, projecting eaves and gables, which would look out of place in smaller villages, more nearly fit the scale of Alnmouth established by its commercial past.

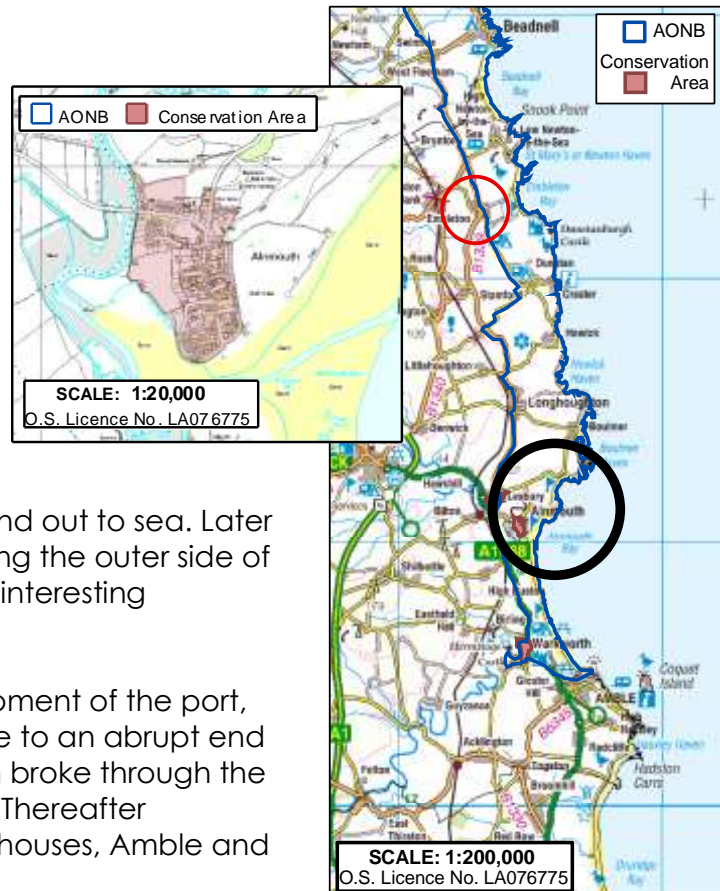

Other developments include an interesting row of experimental concrete houses, Lovaine Terrace built in the 1860's, rendered and cheerfully painted with strong colours more expected in the Mediterranean than on our grey coast.



The main purpose of 20th century householders seems to have been to secure more light into the house and better views out. A new building on the seaward side of the ridge up towards the Priory achieves this successfully with deeply recessed floor to ceiling windows and oversailing roof which fit the landscape well, helped by the scale of the mature sycamore close to it.



Alterations and extensions are many and vary in success. One group of cottages along Northumberland Place illustrates the problem of individual decisions destroying the unity of the whole. Only one owner has retained the original shape of window opening, the others have widened theirs and introduced uPVC frames of different types which are too clumsy for the scale of building.

Even with the larger Victorian Villas some extensions seem overpowering, too large and prominent or with unsympathetic materials detracting from original character.

Warkworth

At the southern tip of the AONB Warkworth is approached from Alnmouth through a screen of trees down a sunken lane to a new road bridge that gives views of the fine medieval bridge with its intact gatehouse. The main street curves slightly, maintaining the surprise of the view up Castle Street to the magnificent Keep and down Dial Place to the Church with its fine tower and spire. It is considered (*by Pevsner*) to be one of the most exciting sequences of views one can have in England.

A range of two and three storey terraced houses mainly 18th and 19th Century stone with slate roofs (though some render with pantiles) form the general character of the village.

Behind the main street frontage lie the unmistakable divisions of long burgage plots of the medieval village some with later housing development at the outer ends approached from the Stanners on the West side and from the Butts to the East.

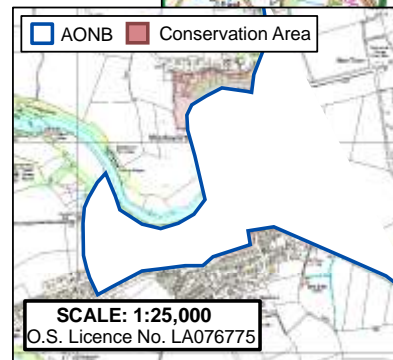

Cars have intruded heavily both in the Main Street and Dial Place, and the riverside grass banks off the Stanners have regrettably become an overspill for further parking.



The compact nature of the old village is rather lost in the new housing to the South of the Castle and although this is outside both the AONB and the Conservation Area it still has an impact on the local character of both. AONB Management Plan Policy LP3 seeks to ensure that development does not compromise the character of views into and out of the AONB.



Northumberland Coast AONB Design Guide for the Built Environment

Design Criteria

The Countryside Agency in their document 'Towards a New Vernacular' set out their stall like this:

"We are seeking an approach to new building in rural areas which is genuine, innovative and sustainable while at the same time enhancing the character of the area in which it is sited and respecting its context."

"A new vernacular building should seek to respond creatively to each of these issues at each level of environmental scale:

- *Energy: Energy consumption in construction and in use should be minimised*
- *Materials: Building Materials should be long lasting or from a renewable source*
- *Flexibility: Buildings should be capable of adaptation and modernisation over time*
- *Quality: Buildings should be healthy, give delight and inspiration and be simple to manage*
- *Environment: New development should seek to enhance the landscape, local character and the natural ecosystem*
- *Community: Development should be part of a viable community"*

All development should aim to enhance the character of settlements and wider landscapes in the AONB by making a worthy contribution to an environment that has taken many generations to evolve. Work that relates closely to existing buildings should draw inspiration from the principles which informed the work of our predecessors.

Does this provide us with clues for Design Guidance here?

Theories of design have a long history. Roman architect and theorist Vitruvius argued three essential characteristics for building:

- | | |
|-------------|------------|
| • Commodity | Commoditas |
| • Firmness | Firmitas |
| • Delight | Venustas |

This theme runs through nearly every subsequent summary of what the aims of building design should be right up to the latest guidance by CABE (the Commission for Architecture and the Built Environment) who expect buildings to be

- Responsive to context
- Fit for purpose
- Coherent
- Understandable
- Practical
- Efficient and Accessible
- Sustainable
- Flexible for the future
- Attractive and pleasing to the eye
- Life enhancing
- Innovative

Some of these attributes nearly say the same thing (thus - efficient/practical, coherent/understandable, attractive/pleasing); others are closely linked in purpose (for instance – sustainable/flexible for the future). Some of the issues we discuss below may be more important than others as a designer considers how best to reflect the particular context of the development in the AONB, but the Design Guide aims to provide criteria to inform the design process and to stimulate discussion about good design in which the community, the developer and the planning authorities can share many of the concepts.

Response to Context

Achieving harmony with neighbouring buildings and the landscape by appropriate siting, massing, scale, proportion, rhythm, materials and landscaping calls for some sensitivity. Each project will need to integrate with its setting by considering these qualities.

- **Siting:** How a building fits into the grain of the landscape in terms of placing and orientation: how in a small settlement a new building should be placed to avoid intruding on a neighbour's privacy or disrupting existing spatial qualities. There will be many practical factors to take into account as well, such as access, orientation, drainage and external spatial function.

- **Massing:** The way the different parts of the development are brought together to achieve a balanced composition with a visual hierarchy. In more complex buildings this will reflect the ordering of spaces into primary and subsidiary functions.



- **Scale:** The human dimension is the constant factor in buildings and is used as the reference point for determining the size of the different elements or spaces of the structure. The proportions of the entrance door to a church may be very close to the proportions of the neighbouring cottage door but we deduce a difference in status by the change of scale: the church door deliberately larger and more impressive.

The change in scale between the country house and the cottage is measured against the human dimension as constant. The proportions of the two doors are the same but we deduce a difference in status by the change in scale.

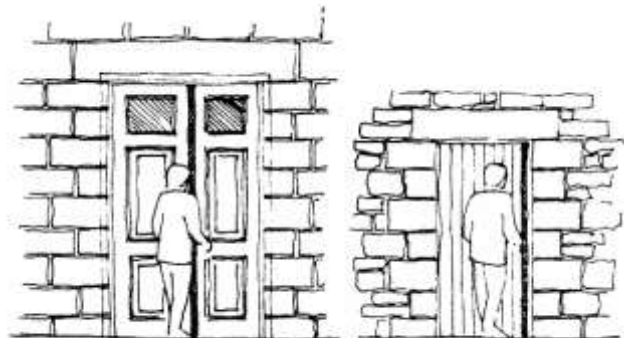

- **Proportion:** Closely allied to scale in defining the relationship of parts to whole and to each other, solid to void and the arrangement of elements. Finely argued mathematical theories of proportion have been in circulation from Ancient Greek academies down to post-war Schools of Architecture: they tend to rationalise what most people can judge with a keen eye for harmony and balance.
- **Rhythm:** the arrangement of constituent parts as a sub-text for the whole: like the satisfactory repetition of a good detail such as the hemmel arch with smaller windows above found in so many Northumbrian farms; the buildings gain their character largely from the interplay of openings and wall



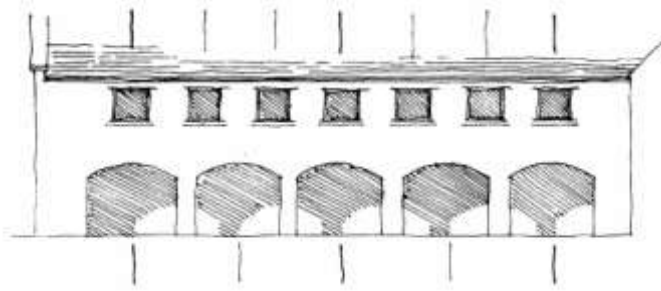

The rhythm of the windows forms a sub-text to the spacing of the arches. The building gains character by the interplay of openings and wall

- Materials and colour:** Our choice of materials and colour is vastly wider than it was for previous generations. Mindful of their achievements and seeking to integrate our buildings today we may voluntarily restrict our palette to materials which will weather well, marry comfortably with existing materials and not strike harsh contrasts. This does not preclude the choice of modern man-made materials nor deny the possibility of deliberate punctuation with bright complementary colour, particularly in this maritime setting where strong colours have an established place.
- Landscaping and external features:** Integration of buildings by thinking carefully about their landscape setting does not necessarily mean elaborate planting or hard landscapes more suited to the town park. Note how this farmstead is tied into the landscape by the enclosing field walls, a clump of two or three mature sycamores and a modulated hierarchy of outbuildings. The detail is not so important as the general setting. In the village more incident may be appropriate, at least careful thought about boundary features and the front gate to the road or green. In dealing with living material in the landscape the time factor must be considered; the long view of the tree grower may need supplementing with shorter-term impact.



Even in the tighter confines of the settlements in the AONB the hierarchy of buildings, garden outhouses and boundary walls or fences, the open green and the street have a major part to play in the way development is satisfactorily accommodated within its context.

Fitness for Purpose

- creating a recognisable building form for the intended use

Good design should ensure that we can recognise a building for what it is and see clearly how it works. A public house or hotel should be designed so that the visitor can clearly see where the entrance is and be made to feel welcome. It is surprising how many fail even that elementary test. Furthermore all new buildings should visibly reflect today's appreciation of the need to provide for disabled people.



In the traditional character of buildings in the AONB there is a hint of the primary and subsidiary functions of different components of a group of buildings. This may also reflect graded status, often subtly hinted at in changes in materials or the way they are handled, for instance a shift from dressed stone to random rubble or from sash windows in the home to casements in the outbuilding.



More obviously the form, structure and materials used in building say a garden centre are likely to be very different from those used in a sheltered housing terrace.

Coherence, intelligibility

- ensuring structural integrity and consistency of detailing

As well as being fit for its purpose a well-designed building should express something coherent about its structure and form. In traditional buildings the structural elements consisted of heavy stone walls punctured by openings for windows and doors: the walls capable of supporting the loads of internal floors and the roof structure. This system was limited by the structural possibilities of timber as grown and the simple rules of carpentry passed down through slow acquired familiarity with joints and fastenings. The size of openings was governed by the simple span of a stone slab for a lintel or could be increased by a more elaborate arch.

The size of window and door openings is governed by the strength of the simple stone lintel – or can be increased by the use of an arch

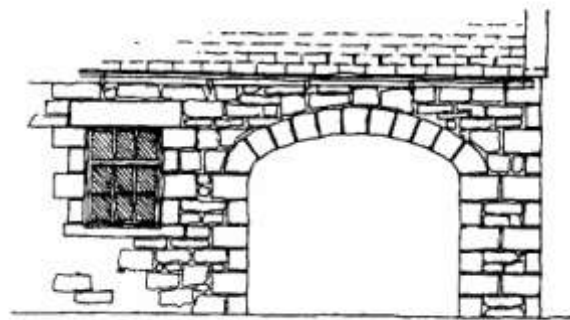

Our knowledge of the properties of materials and our freedom to work in steel and reinforced concrete, our understanding of the performance of laminated timber, makes a new structural articulation possible. It is not surprising therefore that a new vocabulary is being used in contemporary design which we expect will have its own integrity. There are uncomfortable occasions when the structural resources of today are disguised in the clothes of yesterday, most conspicuously in steel reinforced artificial stone lintols to wide openings which natural stone would never have been strong enough to span. The structural capability of steel and reinforced concrete handled frankly to show what they are extends the vocabulary: so too in certain context will the appropriate use of other architectural metals, plastics and glass.



Here the shallow lintol with weak “keystone” pretends to be stone which could not possibly span this double garage opening

Consistency of Detailing

- the careful assembly of components: the way they relate to the character of the whole: an honest use of material

By detailing we do not just mean way in which components of a building are assembled and the intrinsic relevance of the detailing to the whole character. There is very little ornament in traditional buildings in the AONB but much exquisite detailing. So too in the best contemporary work the care and attention given to detailing is manifestly important in understanding a building's quality. In some ways the contemporary designer's task is made more difficult by the far wider choice to be made in materials and components of building construction and services. A deliberate

and voluntary limitation of the palette of materials often helps to make detailing more consistent within a scheme, but again a knowledge of the true character of different materials will lead to appropriate detail for each, whether the materials are those of traditional buildings or of today. Even glass which spans centuries of fenestration excites new solutions to the detailing of edges, fixings and sub-division in contemporary buildings. In this coastal area much detailing will of course be concerned with weather exclusion.

Practical Efficiency and Appropriate Provision

The practical efficiency of a building will depend on imaginative understanding (either before or during the design brief) of how the building is to be used. Good design therefore from the start calls for collaboration and understanding between developer and designer to ensure that the brief is clearer and appropriate resources are made available for the project. It is frustrating for all parties if the ambitions of the owner far outstrip the available funds and changes in the project at a later stage, to achieve savings, can lead to a loss of clarity in the design. If the designer is not fully aware of the intended use of the building it is hardly likely to work efficiently nor is its form going to express its purpose fitly.

Access for disabled people

Public policy has set the pace for making sure that disabled people are not left at a disadvantage in access to and use of new buildings. Equality is an important force in today's democratic society. Equal access is a fundamental right and in new design solutions buildings should incorporate accessibility for disabled people on equal terms with able-bodied as an integral part of the design concept. New building forms may be desired both for the functional requirements of access and for the expression of an open and democratic environment.

General guidance and references to regulations and legislation which covers provision for disabled access are shown in the section **Access for All** as well as being discussed in brief in relation to each type of development.

Sustainability and Flexibility for future use

A former president of the Royal Institute of British Architects, Alex Gordon, commissioned a report in the 1970's, before the word 'sustainability' reached its current political vogue, entitled "Long Life, Loose Fit, Low Energy". This three-part title might well serve to describe the nature of much of the traditional building stock we have inherited in the AONB and to guide us in considering contemporary design towards a sustainable built environment.

Unrestrained by legislation or regulation the owners of property in the past were constantly modifying their buildings to suit changing family size, economic status or developing functional need. Much of the building industry's business today is a continuation of this process and much of the architectural history of the AONB would be dull without it. Traditional building construction has proved remarkably adaptable and robust and reflects the value of sustainability.

Re-using buildings and land

Our ancestors were constantly modifying their buildings to suit changing family size, economic status or developing functional need. Traditional building construction has proved remarkably tolerant and robust.

Designing for minimum waste

The recycling of materials used in traditional building was practiced with commendable frugality, though we might disapprove of the blatant robbing of stone from Dunstanburgh Castle which reappears in farm buildings nearby.

Local sourcing of materials

It is not so easy today to find local sources of building materials.

Minimising energy use

They burnt a lot of cheap fuel and wore thicker clothes to keep warm indoors as well as outside. They had no electricity.

Avoiding pollution

There was certainly a higher level of atmospheric pollution – unpleasant and hazardous to health, but noise and light pollution plus the carbon emissions of the internal combustion engine and the power station have become big concerns today.

Conserving water and recycling waste

They used much less water than we do and their recycled waste was returned to the land. Rainwater harvesting is an ancient skill.

The whole place

Respect for site and setting, the efficient use of land, the appropriate definition of the village envelope, the coherence of pedestrian and vehicular routes through settlements usually have a logic to them and help to create a sustainable sense of place.

Supporting biodiversity

Traditional buildings are much more hospitable to wildlife than modern buildings generally, and in our stewardship of the older building we should avoid reducing the freedom to lodge.

Sustainability is not a new science but a very old attitude and practice which we in the wealthy developed world have lost sight of and must learn again.

Although the criteria now established for designing with sustainability in mind relate to all kinds of building activity there is a much greater need today for conscious responsibility in contemporary design when using materials sourced from all over the world and technologies that depend on much off-site preparation. The problem for the designer is to discover what the environmental costs of production and transport of materials has been, as well as the future implications of incorporation in the building of materials perhaps relatively untested by time and environment. It requires a positive choice to minimise waste and maximise future benefit from robustness and adaptability. This will be a major influence in the design of the building and in the expression of the building form.

A fuller discussion of the efficient use of resources and of other aspects of designing for sustainability is contained in the section **Sustainable Construction** as well as being discussed in brief in relation to each type of development.

This is an important and far-reaching issue and includes consideration of:

Site design, orientation, environmental impact

Minimising waste in production, transport, incorporation and use

Pollution in production and use

Renewable energy

Biodiversity

Water and drainage

Social and economic sustainability

Innovation and Outstanding Design

The principal aim of the Design Guide is to draw attention to the locally distinctive character of the built environment of the AONB and to encourage an understanding of its development, both in the past and into the future.

In the vernacular tradition the patient growth of a customary way of doing things in a settled community will have guided owners and builders in the AONB surely enough. Over two or three hundred years the relative isolation from national or continental movements in education or taste would favour local over external influences.

However, at least with wealthier landowners and the Church, a wider cultural vision was at work and the AONB has some impressive examples of buildings that were not

intended to be lost in the crowd, Howick Hall, Warkworth and Dunstanburgh Castles, Bamburgh Church and Lindisfarne Priory, all confidently express the idea of 'conscious' design from their time.

Similar motivation towards outstanding design still operates today. Whether meeting the need for a new contemporary function or designing an exuberant icon for the culture of today living architects and engineers can justly claim their place in this current of outstanding 'conscious design'. One can hardly ignore the impact on the Tyne Quayside of the Sage Concert Hall, the Baltic Arts Centre and Gateshead Millennium Bridge. At Durham the fine combination of the Students Union with the high level footbridge make a lasting impression from the 1970's. In rural areas it is more difficult to list iconic work in the North-East but the Reception Building at Fountains Abbey handles the experience of visitor welcome and interpretation with panache and the new extension gallery, library and reading space at Wordsworth's Dove Cottage, Grasmere is a brilliantly controlled juxtaposition of elemental forms on a tight site.

Although the private house is the medium many successful architects regard as the most rewarding field for experimental design the Planning Authorities expect that the focus of outstanding new design will include places of public gathering, the leisure facility, visitor centre or museum. In such a context the experience and expectation of the visiting public plays an important part. Today's visitors to Northumberland will bring their own experience of tourist facilities in many other parts of Britain or Europe and will judge our achievements by the standards found elsewhere. The highest standards of design for special projects of particular significance will be encouraged and alternative approaches to form and materials will be considered sympathetically where the designer can demonstrate the need to extend the vocabulary of the built environment to respond to the particular conditions of the brief.

Projects of this type will be reviewed by a panel of experts in consultation with the planning authorities and will still be measured against the Design Criteria drawn out in this section. They may also warrant pre-application consultation with the local community in accordance with the local planning authority's Statement of Community Involvement.

Safe designs tend to mimic their surroundings, or utilise a pastiche of architectural details. Such designs contribute just as surely to the destruction of local distinctiveness. To counter these trends contemporary designs that respect their context, but which make more imaginative use of the fundamentals of architecture, should be encouraged.

“Design Policy to Design Quality” Royal Town Planning Institute



Northumberland Coast AONB Design Guide for the Built Environment

Repair and Maintenance

Much the greatest part of the building industry's activity in the AONB must surely be in minor acts of maintenance and repair to existing buildings. Whether it is initiated by a landowner or a tenant or by the many private house-owners this work can be seen as part of the continuing activity of care for property which ensures that the operational efficiency and value of buildings is maintained. After all it doesn't cost much to clear a blocked gutter or replace storm damaged tiles, but if left unattended the damage caused by water entry to structural timber, plaster ceilings and window frames can be far, far more expensive and disruptive to rectify.

The AONB Management Plan includes :

Policy LP5:

Improve quality of design of new buildings, alterations and maintenance work and in materials and skills employed through provision of advice and design guidance. Resist proposals that would have an unacceptable impact upon landscape quality, settlement character, a feature of historic importance or its setting.



So there is a strong measure of self-interest in this remedial work, but it is also an essential way of protecting the character of traditional buildings handed down to us and to be passed on to future generations. We have a role as stewards to maintain both the fabric and the character of this building stock and can, by many small acts of intervention, fulfill that role. There is however a danger that by many small acts we can also undermine the valued character of traditional buildings.

The unity of this pair of cottages has been lost as the owner on the left has decided to make changes without regard to the neighbouring property.

Not only have the windows been replaced by incongruous bow windows and the traditional door with full height glazed panels but the render has been hacked off the ground floor to leave very rough stone exposed.



This part of the Design Guide is intended to help the property owner judge how these acts of maintenance and repair can best be planned and executed to protect the character of their property.

The Structure

Re-pointing

Since so much of the stock of traditional buildings in the AONB is natural stone it is worth understanding how best to repair and re-point walls that have become weakened by weathering and loss of mortar. Re-pointing is only necessary when mortar joints have perished and the mortar is breaking down, losing its structural integrity.

It is worth remembering that mortar is not glue: its function is to cushion and fill, not to stick. Some very strong cement-based mortars can be used as adhesive but for most purposes these strong mixes are both unnecessary and can seriously damage the long term condition of the stone, particularly with the sandstones of the Northumberland Carboniferous measures. When walls get wet the moisture they absorb moves if it can to the mortar joints from where it evaporates. Traditional lime mortars allow maximum breathability and they don't crack as a result of building movement or temperature change. Hard cement-rich mortars are much less forgiving and tend to trap moisture which through the action of frost and the concentration of salts accelerates the decay of the stone. It is always better to ensure by the deliberate choice of a mortar weaker than the stone that in the long process of weathering it is the pointing that is sacrificed not the stone.

Where re-pointing is needed the existing mortar should be raked out using hand tools only to a minimum depth of 30 mm. The prepared joint should then be cleaned with a stiff brush and flushed out with a light spray of water. Advice from an architect or building specialist will be helpful in selecting an appropriate mortar mix. However in many instances re-pointing using a mortar consisting of 1 part of moderately hydraulic lime to 3 parts of sand or of one part cement to 2 parts of hydrated lime putty and 9 parts of sand should prove satisfactory.

Mortar will normally have an off white, cream or brown colour though in parts of North Northumberland the local sand may impart a red/pink colour. In areas of the AONB where Whinstone was used as a building stone it does seem that traditional pointing with lime mortar accepted the sharp contrast between the dark (sometimes nearly black) stone and the pale cream mortar. Modern taste might prefer less contrast and lime mortar with a high proportion of crushed Whinstone aggregate (4 mm down to dust) might meet that preference. The preparation of a couple of sample areas using mortar mixes with different sands should help to ensure a good colour match. Allow the mortar to dry out for two days to reveal its true colour. By mixing concreting sand with building sand the mortar will more closely resemble a traditional texture with coarse aggregate.

It is the stonework which should predominate, not the mortar



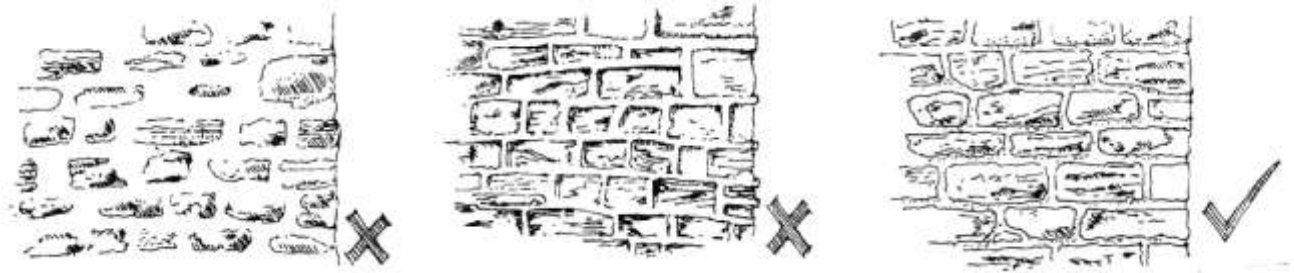

Finishing the joints just behind the stone face allows the stones to “read” and generally produces the best appearance: it is also the least likely to cause long-term damage to the stone. The hard lines of raised “ribbon” pointing serve no purpose of benefit to the stone and have a rather aggressive appearance. In very poor random rubble masonry it is difficult to avoid buttering mortar over some areas of face but it is not good practice and can trap moisture behind mortar and damage the stone. The most pleasing results can be got by pointing the joints flush and then after the initial set stippling the surface so that it is slightly recessed and shows some of the coarse aggregate. Where the edges of stonework have eroded, pointing should be recessed to the original joint width.

Stone repairs

In some older buildings the face of stonework may have been weathered back in a way that leaves flakes of stone only loosely attached to the wall. These should be brushed or picked off, since they will fall off in due course anyway, and the wall left in sound (if weathered) condition. Individual stones that have become so worn away as to threaten the structural integrity of the wall can be cut out and a new matching stone built in or a section of stone neatly cut out and a new piece indented. This is work better done by a skilled mason and needs a fair amount of precision.

Render

It is typical of coastal settlements in Northumberland that a much higher proportion of buildings have a render finish over the structural walling material and the use of strongly coloured paints on render is almost a convention of maritime architecture. The severe exposure to wind, driven rain, spray and salts is a testing environment for any form of construction whether traditional or modern and practical experience of combating damp and decay is the common link behind decisions to render a building.



Small cottages and a bungalow with traditional pale render and simple stone detailing



A terrace in Craster showing the use of painted render in a variety of colours

Early practice in the application of a shelter coat relied upon a lime and sand mix with a capacity to breathe. This would absorb rainwater to saturation point (any surplus tending to run off outside) and then release it by evaporation outward in an even way. A decorative finish of lime wash (slaked lime stirred to a slurry and applied in quite thick coats) would be refreshed quite frequently: this too was part of the breathing shelter. Occasionally these protective coats have been removed in the interests of showing the stone only to find that dampness becomes a problem again. Even more substantial buildings such as Lindisfarne Castle may have been rendered though the practical problems of access to maintain this above its rocky plinth seems to have discouraged continuation of this practice. In spite of this difficulty parts of the Castle have been re-rendered within the last decade.

Where renders are to be replaced a slightly stronger mix may be appropriate but, as with pointing, should not be stronger than the stone – a 1:1:6 (or 1:2:9) cement lime sand. Some textured renders are referred to as wet dash or rough cast. This involves the finishing coat mix which contains small pebbles being thrown against the undercoat from a casting or dashing trowel with a flicking action and being padded in for adhesion.

There are many proprietary renders on the market with a wide range of 'through' colour and texture. Great care is needed in their selection and use as many are inappropriately strong for the softer stones or lightweight blockwork now specified to achieve high levels of thermal insulation. The design of the blockwork and render to include movement joints against early shrinkage cracking has to be taken seriously. The other problem (which may be a matter of taste) is that the aim of modern practice in rendering is to achieve a perfectly flat even surface with sharp mechanical details at corners and openings with little colour variation. This alone marks modern practice out as different in result from the softer modelling of traditional lime render and the local authority may press the owner of a traditional building to pursue the traditional finish.

Roofs

Welsh slates and clay pantiles form the dominant roof covering for buildings of all types in the AONB. In a few cases the lower courses of steep pantiled roofs have three or four courses of heavy stone slabs which are designed to slow the water run-off and spread it more evenly into the gutter. Whatever the case may be for repair and maintenance the best course is to replace like for like to achieve a matching invisible mend. A slip of lead sheet might be used in an emergency after a storm, but most good roofers will carry stock of tiles, stone slabs and slates with which to effect repair. Even with ordinary slates though there is a natural diversity of colour and texture and as the market expands in imported Spanish or Chinese slate (which incidentally have a high indirect energy cost attached to them in the distance transported from source to consumer) this must be taken into account. Second-hand "Scotch" slates are becoming more difficult to find since the production of new slate has ceased in Scotland.



Buildings with juxtaposed pantile and slate roofs. Note that in all cases there is a larger expanse of slate but the pantile becomes dominant due to its bright colour.



Pressed concrete or fibre-cement slates are not really suitable for repair work. They probably will not match the older natural slates even to start with, but there is no doubt, even if they do, that the weathering process will affect them in a different way which will become more marked over time.

Many traditional buildings have stone ridge pieces which, if they are sound, should certainly be retained and rebedded. If these are not available use blue/black clay ridges for slate roofs and half round red clay ridges with pantiles.



Farm buildings and smaller community halls, chapels and seaside chalets have often been roofed with asbestos cement or metal sheet. This can be visually very pleasing and is part of the character of this inexpensive type of building. Modern fibre-cement profiled sheeting has superseded asbestos and plastic coated metal of an appropriate colour provides an acceptable alternative.

St. Mary's Church at Newton by the Sea

With the growing prosperity of the settlements in the AONB in the 19th and early 20th century many buildings show much great elaboration, with projecting gables with ornate barge boards, bay windows with lead covered roofs, turrets with steep slate roofs crowned with decorative iron finials or moulded terracotta hip terminals

Chimney stacks in stone or brick, sometimes with bold moulded cornices, were finished with a wide range of decorated clay chimney pots, reflecting a much wider range of manufactured articles which could be bought in form outside the area. These are all important features and should always be retained or replicated. Their repair and maintenance may require specialist skills and particular materials suitable to the work.



Dormer windows, bay windows, balconies, gables, chimneys are all shown here as more elaborate



Rainwater Goods

Gutters and downpipes on traditional buildings are usually cast iron, half round or ogee shape, though timber gutters were also popular. Gutters are usually fixed by simple rafter straps or decorative spiked brackets made by local blacksmiths. Some Victorian and Edwardian buildings have gutters supported by elaborate timber fascias. These traditional features should be retained. Modern fascia boards to support gutters are unnecessary, present a continuing maintenance problem and detract from the appearance of a building. Plastic rainwater goods may seem like a cheap alternative but are not robust and frequently buckle following a snow slide off a roof or can be damaged by ladders.

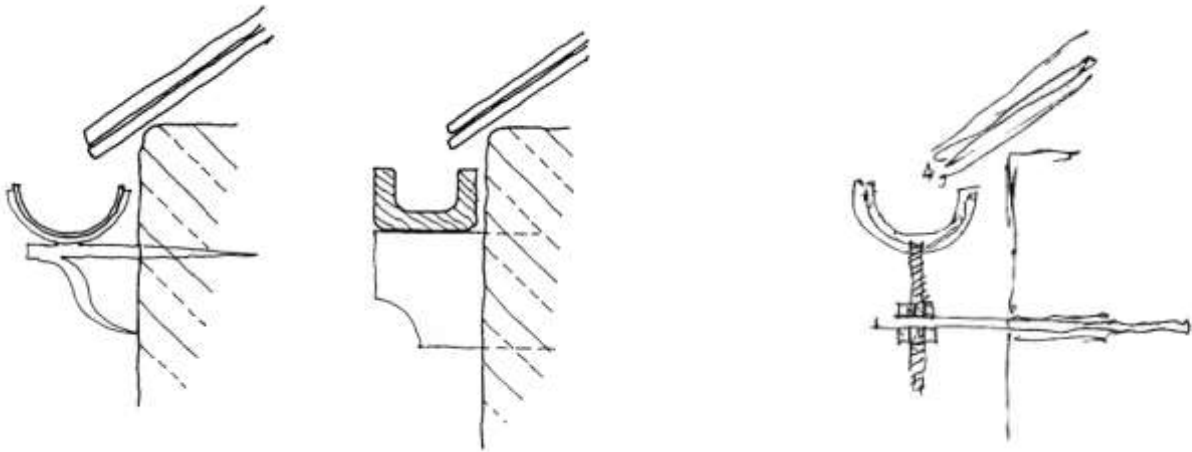

Cast iron gutters traditionally fixed on drive-in brackets direct to the masonry. Wooden gutters were often supported on projecting stone brackets. Neither detail necessitated timber boards at the eaves

Modern adjustable brackets can be used to provide minimum falls in gutters to outlet

Windows and Doors

It is in the design of windows and doors and the impact of decisions about repair or replacement that the greatest change to a building's character can be made. The decisions to be made are complex and understandably the aim of many home-owners is to reduce draughts, improve insulation and save fuel costs. Some will argue that the traditional small pane window obstructs the view and is difficult to paint: so why not take an old window out and install a large new casement with a uPVC frame, sealed double glazed unit, and no maintenance?

The balance of argument between timber and uPVC, taken in the round, favours the use of the naturally renewable timber with lower embodied energy and more sustainable sourcing. uPVC is claimed to be maintenance free, but over a comparable life span of many existing 18th and 19th Century timber windows (i.e. 150 –200 years) uPVC would be expected to discolour and lose its nature, and damage to it (break-in or distortion) is not possible to repair without complete replacement. Furthermore uPVC and metal windows too require enormously more energy to produce than timber windows and involve costs of pollution and the disposal of hazardous chemicals.

Through the public consultation process the AONB Partnership has heard arguments in support of timber and uPVC nearly balancing each other in passion and conviction; nevertheless the AONB Partnership is convinced that it has a primary duty to press for the continued use of timber windows and doors in the context of its conservation aim to protect the character of traditional buildings throughout the AONB.

The debate about windows and doors does not of course stop only at the timber/uPVC issue. A defective door or window may need a decision as to whether it can be repaired or should be replaced. A good joiner can often tackle repairs and make a casement or sash weathertight and stop it rattling. There are specialist firms who strip down sash windows and fit the staff and parting beads and the meeting rails with draught sealing nylon brushes, achieving enormous improvements in thermal performance without in any way changing the appearance of windows.



*This uPVC door tries to emulate traditional detailing and style but fails miserably
Two different styles of window have been used, the lower one far too wide and with inappropriate 'stick-on' glazing beads*

*These uPVC windows are not traditional in style with their top-hung opening lights and their stuck-on glazing beads
They are also set too far forward in the window reveal*





These windows try to copy traditional sliding sash windows but uPVC sections are too large leaving little space for the glass

However, the implications of the Building Regulations Part L Conservation of Fuel and Power is quite clear that single glazing on its own provides little effective insulation and that double glazing will become the norm for windows. It is true that attempts to install double glazing units into traditional window sections cannot be made without substantial change to the profile of the timber sections making them rather clumsy. It may be less intrusive to introduce secondary glazing in a removable frame inside the window to protect the external appearance though any sub-divisions of the secondary glazing will be visible from outside unless they are carefully aligned with those of the original window.



A selection of windows that do not suit for replacement in old buildings

The design of today's doors and windows should draw from the good examples of the past

The Building Regulations do recognise the sensitive issue of working on historic buildings including specifically *'buildings of architectural and historical interest within National Parks, Areas of Outstanding Natural Beauty and World Heritage Sites'* Building Inspectors will *'take into account the advice of the local planning authority's Conservation Officer'* particularly where work relates to *'restoring the historic character of a building that had been subject to previous inappropriate alterations e.g. replacement windows, doors and rooflights'*. In such work the aim should be to improve energy efficiency where and to the extent that it is practically possible always provided that the work does not prejudice the character of the historic building. The footnote on historic buildings also makes the important point that, the 'biology' of an old building is different from a modern structure and encourage *'making provision to enable the fabric of historic buildings to "breathe" to control moisture and potential long-term decay problems'*.

Painting

The character of many seaside towns and villages around Britain is established by the cheerful paint colours of older property. In the AONB a little of this maritime bravura comes across in Lovaine Terrace in Alnmouth and although colours elsewhere are generally more reticent there are many painted buildings in Holy Island, Seahouses, Embleton, and Beadnell – old as well as new.



Paint, generally lime wash as a traditional finish to rendered masonry, is now more usually an exterior masonry paint with improved bond and colourfast characteristics. These have a wide range of soft colours which weather nicely and do not reveal patchy salt stains too obviously. Strong colours such as Ultramarine and Crimson Lake have more pigment and less body and offer less effective cover. On the whole it is not advisable to paint an old building direct to the stone as a high level of residual salts left by years of evaporation will tend to discolour the paint or contribute to a breakdown in the bond between the paint system and the stone.

For joinery a distinction seems to be well established between the colours chosen for painting joinery in windows and doors to housing (whites with perhaps bright clean colours for the front door) and the doors and frames of outbuildings, warehouses and farm buildings – usually darker reds, blues and greens, perhaps less likely to show dirt. This distinction should not lightly be ignored. Brilliant White, so popular with the DIY trade, can be very harsh and alternative soft whites, creams and soft greys do work well with honey coloured stone of this area and these colours will provide a little relief to the dark whinstone of Craster or the redder sandstones of Bamburgh. The use of wood stains for new work is acceptable but will not protect traditional glazing putties. It is usual in this context to use timber glazing beads pinned over an appropriate glazing compound.

Development Control

Many of the smaller acts of repair or even replacement described in this section do not require planning permission and are entirely for the decision of the property owner. However in the case of Listed Buildings it will be necessary to obtain Listed Building Consent even for what may seem straight-forward repair or relatively minor alterations. These may include changes of materials, provision for disabled access, replacement of doors or windows, the alteration of the setting of the building or the introduction of external lighting. Although some of this control may seem burdensome it is better at an early stage to consult with planning staff than to find later that work is not lawful.

Conservation Area consent is required for the demolition of an unlisted building in a Conservation Area.

Sustainability

The repair and maintenance of existing buildings is a fundamentally sustainable process continuing the habit of previous generations in making good use of existing structures and space. Designing for durability in the first place helps to reduce the amount of maintenance required and over a long life-span of a building will minimise future consumption of resources.

A fuller discussion of the efficient use of resources and of designing for sustainability is contained in the section **Sustainable Construction**.

Bats and Birds

All British Bat species are given special protection within England by their inclusion in Schedule 2 of the Conservation (Natural Habitats) regulations 1994 and Schedule 5 of the Wildlife and Countryside Act 1981. All wild birds their nests and eggs are protected by law.

Minor maintenance and repair of existing buildings may not necessarily affect bat or bird habitat, but larger scale repairs to roofs, barge boards, eaves or work in roof spaces, eave re-pointing open joints in old masonry, requires care to ensure that protected species are not disturbed. Advice on what steps to take can be sought from Natural England, North East Office.



Northumberland Coast AONB Design Guide for the Built Environment

Alterations and Extensions



Investment in Existing Buildings

The great majority of planning applications submitted in the AONB involves alterations or extensions to houses or proposals for the conversion of redundant buildings to new use. A great deal of time and effort is given by house owners to home improvement and the need for change and adaptation of much of the existing building stock to meet future needs is recognised. This ongoing investment in the fabric of our older buildings ensures their lively usefulness, writing its own history on the face of a building and creating its own character.

The Planning Authorities are however concerned at the impact of alterations and extensions which do not reflect the quality of the original structure, surrounding buildings or setting. We hope that more careful consideration and respect for the character of existing buildings through using the guidance contained in this section will encourage improvement in contemporary alterations.



The AONB Management Plan includes :

Policy LP5:

Improve quality of design of new buildings, alterations and maintenance work and in materials and skills employed through provision of advice and design guidance. Resist proposals that would have an unacceptable impact upon landscape quality, settlement character, a feature of historic importance or its setting.

Respecting character

Acceptable forms of alteration are many and varied recurring over a wide area and long time-span. The key characteristic of almost all successful extensions lies in the respect shown to the original building so that the existing volume or massing of the house remains the dominant form. The examples that follow show that extensions can be built at different periods and yet show the same respect for the character of the original.



A house with a history of past extensions, both in line at the ends and as a lean-to at the back including a timber clad log store. All the extensions with the exception of the store are in stone with slate roofs, but all remain subsidiary to the house

A neighbouring house has recently been extended both in line and as an offshoot at right angles to the main building. Note that the single storey offshoot roof tucks in under the main eaves. New volumes are subsidiary to the whole.





A two storey back extension maintains the gutter/eaves line of the original house but being narrower its roof ridge is well below the original ridge, thus retaining the subsidiary relationship. Another acceptable form of extension at the gable is a simple lean-to with a slate roof with a lead flashing tucked into a horizontal chase in the main house wall

All the examples above relate to two storey houses retaining a clear distinction between dominant and subsidiary volumes and show the importance of the roof form in retaining that hierarchy. Greater difficulties occur when the desired extension is closer in volume to the original building and particularly in the case of single storey cottages. If space is available it is generally more satisfactory to extend outward to the side or rear rather than attempt an invasion of the front or of the roof space.



The extension here is set back a short way from the plane of the original cottage and the roof line is slightly lower; both helpful in ensuring that the original pretty cottage is unspoilt

The juxtaposition of a contemporary extension to the main body of an existing building can best be handled by contrasting an extremely lightweight and transparent structure using high quality materials and detailing either for the extension or as a link to a heavyweight masonry component. The transition from old to new allows the form of the original building to be clearly identified and conserved.



Lightweight extension of traditional stone cottage in timber and glass

Roofs

Handmade clay pantiles and Welsh slates are very much the dominant roof covering of the AONB, though later 20th century extension of the palette to include machine pressed tiles of many types including pantiles that closely match the older handmade ones at half the price. Farm buildings and smaller community halls and chapels have often been roofed with profiled asbestos cement or metal sheet. This can be visually very pleasing and is part of the character of this inexpensive type of building. Modern fibre-cement profiled sheeting has superseded asbestos and plastic coated metal of an appropriate colour provides an acceptable alternative.

For alterations and extensions the best course is to use similar material to the original roofing to maintain the character of the building. Most good roofers will carry stocks of tiles, stone slabs and slates with which to effect this. Even with ordinary slates though there is a natural diversity of colour and texture and as the market expands in imported Spanish or Chinese slate (which incidentally have a high indirect energy cost attached to them in the distance transported from source to consumer) this must be taken into account. Second-hand 'Scotch' slates are becoming more difficult to find since the production of new slate has ceased in Scotland.



Rainwater Goods

Gutters and downpipes on traditional buildings are usually cast iron, half round or ogee shape. Gutters are usually fixed by simple rafter straps or decorative spiked brackets made by local blacksmiths. Modern fascia boards to support gutters are unnecessary, present a continuing maintenance problem and detract from the appearance of a building. Plastic rainwater goods may seem like a cheap alternative but are not robust and frequently buckle following a snow slide off a roof or can be damaged by ladders. Aluminium cast or extruded is an alternative material but must be effectively protected from salt laden spray as bare aluminium reacts chemically with salt.

Dormer Windows

The importance of retaining the original roof form has been mentioned above. Loft conversions are recognised as a way of creating more space in the home whether in single storey or two storey dwellings. Where this can be achieved without major external change to the roof form such extensions upward may be granted permission.

The insertion of large flat roof box dormers as shown below will not be acceptable but a number of smaller types of dormer could be considered in certain positions. These should be small scale, closely related to the size and position of existing windows.

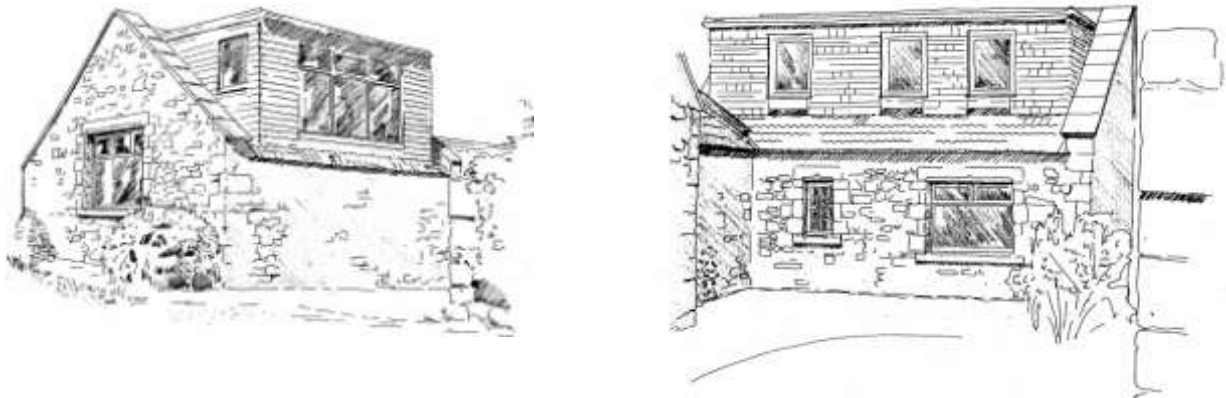

With all these examples the dormer construction is so intrusive that the original roof plane has become invisible. The box dormers in the two examples above are too large; the gabled dormers below are too many, overpowering and too far up the roof.



Dormer windows are fairly common in the AONB. The most satisfactory and persistent type forms a continuation of the wall face rising in stone to a coped gable with a slate pitched roof. These form a coherent elevation with windows matching those below and are usually built with the original development rather than as a later addition.



The issue shown above in these two older properties is the interruption of the rainwater gutters – note the number of rainwater pipes – but the form is traditional

There is a slightly continental feel to this repetition of dormers, right, creating a satisfactory composition. The main roof surface is still the dominant component and the dormers rise from the wall plane.



An interesting design with hint of Arts and Crafts. There is still plenty of roof slope visible



Square lead covered dormers – an alternative still subsidiary to the main roof surface

Other forms of dormer are placed on the roof slope and are therefore of lighter construction with slate or timber clad side cheeks and gabled or hipped roofs to match the main roof material. Flat felted roofs to small dormer windows look mean and are not an acceptable form. In the north of Northumberland, and throughout the Scottish Borders, another form of dormer persists, three faceted with a hipped roof usually running into the main ridge and with slate hung cheeks. All these dormer windows are usually associated with a fairly steep main roof slope providing sufficient space in the roof void to make conversion worthwhile.

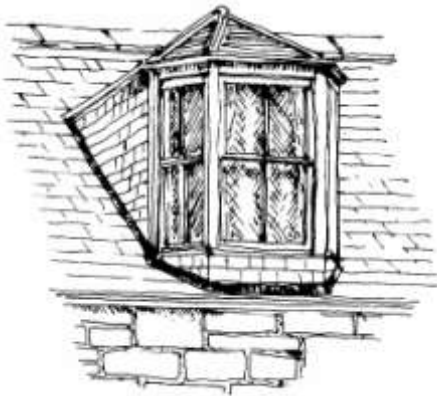

Roof windows may be a less intrusive way of bringing light into new roof rooms but can still affect the appearance of a dwelling if they are too many or too large. Their position and size should be considered carefully to reflect the existing window patterns and to avoid breaking up the main roof plane.

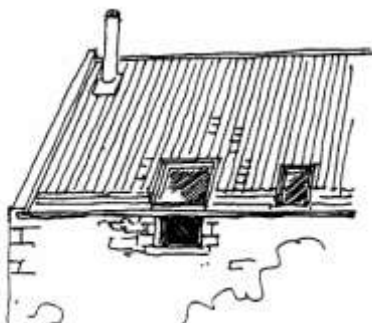

Elaborate gablets to late 19th century villa



Single dormer on an extension



Another version of dormer with catslide roof

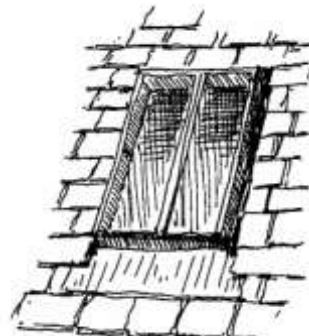

Conservation Rooflight – this is well suited to older buildings due to its low profile within the roof plane

Alternative ways of handling more extensive roof lighting

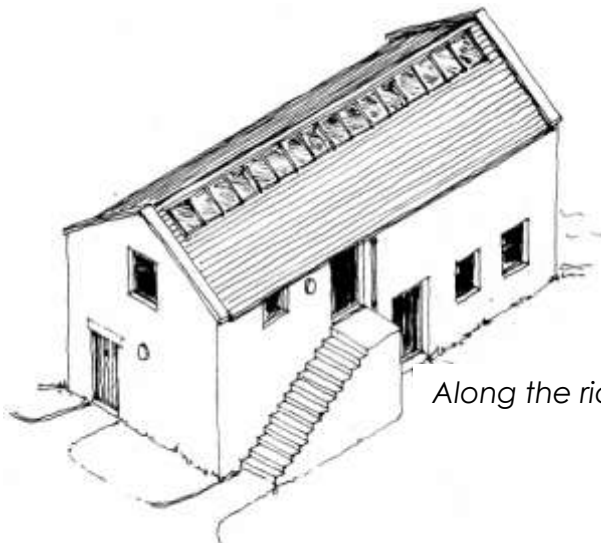

Along the ridge

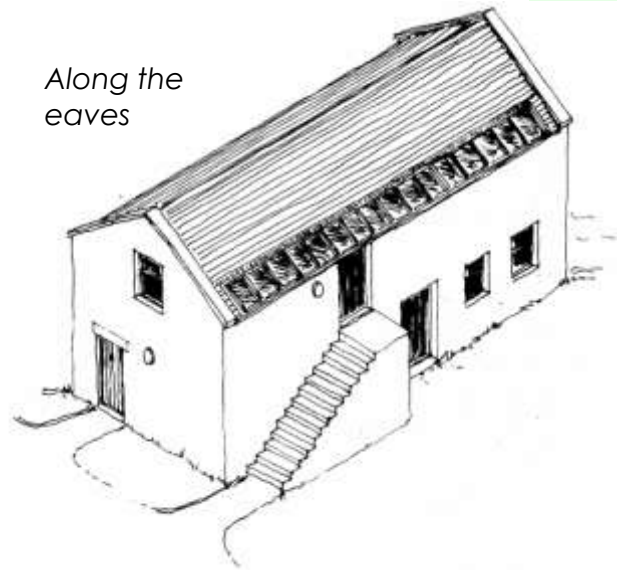

Along the eaves

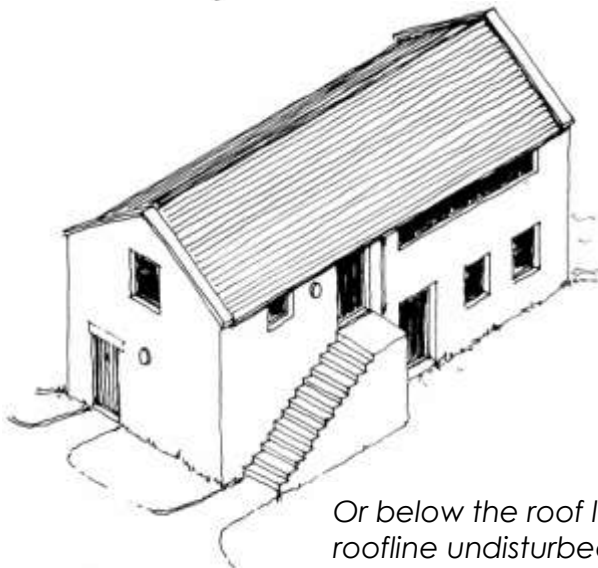

Or below the roof leaving the roofline undisturbed

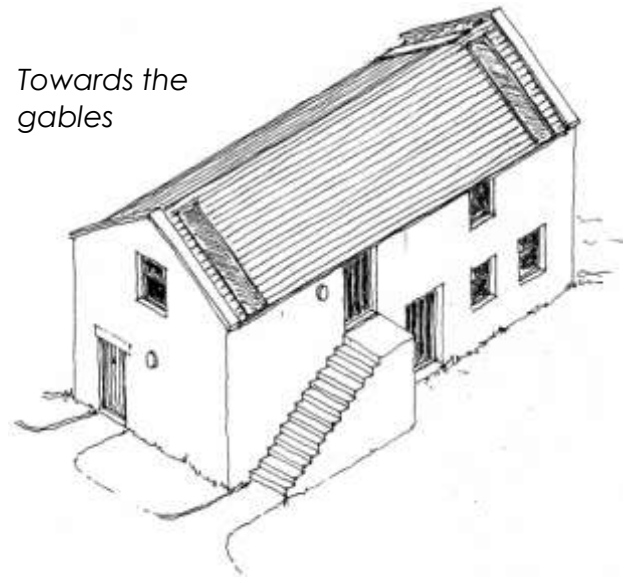

Towards the gables

Porches

In the exposed windy climate of the coast it would be natural to expect that porches should be a regular element of protection. In fact there is no very strong evidence of this historically and the porch is perhaps more a product of the 20th Century added onto existing houses than it is a contemporary of the original house. In fact it seems that previous generations took a good deal of care to seek shelter from wind and weather by siting houses away from the most exposed quarters. It can sometimes therefore present a problem to design a new porch satisfactorily. One of the difficulties is getting the scale right. A simple transitional shelter covering the front door can look insignificant and if open fronted can hardly be claimed to achieve any useful purpose. At the other extreme many porches move towards being sun rooms or lobby extensions and become too prominent on the front of the house. Another common problem affects the proportions of the porch where a front door has a first floor window directly above it. This restricts the height of the porch roof and may influence the design response.

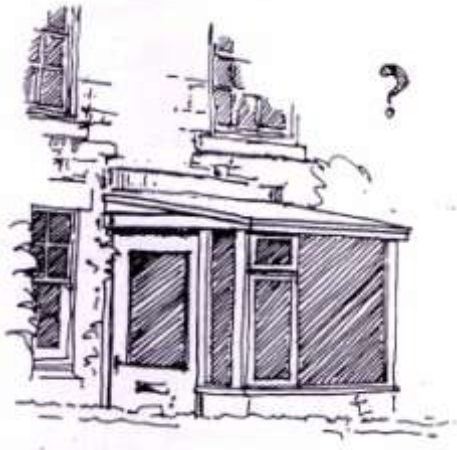

Here the porch has nearly become a conservatory but lacks the grace one might expect. The felt roof may well have been a way of avoiding a clash with the upper floor windows

It is hard to see the point in building this small and ill proportioned 'shelter' to the front door

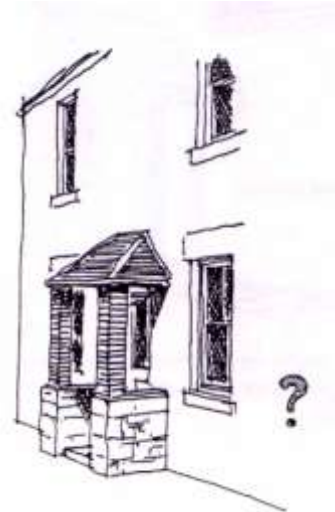

These previous examples are not a very good start, but there is a wide variety of robust, pretty or amusing porches as examples of acceptable design in the AONB. Many of these have a stone base with timber framed side windows and front door. The more robust porches are built of stone full height; the prettier porches include some from the late 19th Century with elaborate timber barge boards and finials; the late 20th century tends to be more severe and some regrettably make no contribution to their houses.



A couple more recent porches add to the lively record



Windows and Doors

It is in the design of windows and doors and the impact of decisions about replacement that the greatest change to a building's character can be made. The decisions to be made are complex and understandably the aim of many home-owners is to reduce draughts, improve insulation and save fuel costs. Some will argue that the traditional small pane window obstructs the view and is difficult to paint: so why not take an old window out and install a large new casement with a uPVC frame, sealed double glazed unit, and no maintenance?

The balance of argument between timber and uPVC, taken in the round, favours the use of the naturally renewable timber with lower embodied energy and more sustainable sourcing. uPVC is claimed to be maintenance free, but over a comparable life span of many existing 18th and 19th Century timber windows (i.e. 150 –200 years) uPVC would be expected to discolour and lose its nature, and damage to it (break-in or distortion) is not possible to repair without complete replacement. Furthermore uPVC and metal windows too require enormously more energy to produce than timber windows and involve costs of pollution and the disposal of hazardous chemicals. Metal windows whether steel or aluminium may be a particular problem in coastal areas owing to the vulnerability of bare metal to the aggressive action of salt. Once rusting or corrosion starts it is extremely difficult to control and repainting will fail all the quicker.

There is therefore a convincing case for the continued use of timber windows and doors in the context of their conservation aim to protect the character of traditional buildings throughout the AONB.

The debate about windows and doors does not of course stop only at the timber/uPVC issue. A defective door or window may need a decision as to whether it can be repaired or should be replaced. A good joiner can often tackle repairs and make a casement or sash weathertight and stop it rattling. There are specialist firms who strip down sash windows and fit the staff and parting beads and the meeting rails with draught sealing nylon brushes, achieving enormous improvements in thermal performance without in any way changing the appearance of windows. However, the implications of the Building Regulations Part L Conservation of Fuel and Power is quite clear that single glazing on its own provides little effective insulation and that double glazing will become the norm for windows. It is true that attempts to install double glazing units into traditional window sections cannot be made without substantial change to the profile of the timber sections making them rather clumsy. It may be less intrusive to introduce secondary glazing in a removable frame inside the window to protect the external appearance though any sub-divisions of the secondary glazing will be visible from outside unless they are carefully aligned with those of the original window.

We ask you to look at the section on Repair and Maintenance for more detail on suitable window design.

Render

Although many of the older buildings in the AONB are of stone construction or of brick, there is a well established practice of rendering external walls in exposed maritime areas.

Early practice in the application of a shelter coat relied upon a lime and sand mix with a capacity to breathe. This would absorb rainwater to saturation point (any surplus tending to run off outside) and then release it by evaporation outward in an even way. A decorative finish of lime wash (slaked lime stirred to a slurry and applied in quite thick coats) would be refreshed quite frequently: this too was part of the breathing shelter. Occasionally these protective coats have been removed in the interests of showing the stone only to find that dampness becomes a problem again. Even more substantial buildings such as Lindisfarne Castle may have been rendered though the practical problems of access to maintain this above its rocky plinth seems to have discouraged continuation of this practice. Here however the National Trust has, in spite of the difficult access, re-rendered some walls within the last decade.

Where renders are to be replaced a slightly stronger mix may be appropriate but, as with pointing, should not be stronger than the stone – a 1:1:6 (or 1:2:9) cement lime sand. Some textured renders are referred to as wet dash or roughcast. This involves the finishing coat mix which contains small pebbles being thrown against the undercoat from a casting or dashing trowel with a flicking action and being padded in for adhesion.

There are many proprietary renders on the market with a wide range of 'through' colour and texture. Great care is needed in their selection and use as many are inappropriately strong for

the softer stones or lightweight blockwork now specified to achieve high levels of thermal insulation. The design of the blockwork and render to include movement joints against early shrinkage cracking has to be taken seriously. The other problem (which may be a matter of taste) is that the aim of modern practice in rendering is to achieve a perfectly flat even surface with sharp mechanical details at corners and openings with little colour variation. This alone marks modern practice out as different in result from the softer modelling of traditional lime render and the local authority may press the owner of a traditional building to pursue the traditional finish.

Painting

The use of strongly coloured paints on render is almost a convention in maritime settlements. The clear and rich colours of the Mediterranean or the Atlantic shores of Britain seem to evoke and justify bold response in the colours of paint. As it happens the Northumberland Coast does not boast many examples. A little of the maritime bravura comes across in Lovaine Terrace at Alnmouth. Elsewhere colours are generally more reticent though there are many painted buildings in Holy Island, Seahouses, Beadnell and Embleton – old as well as new.

Paint, generally lime wash as a traditional finish to rendered masonry, is now more usually an exterior masonry paint with improved bond and colourfast characteristics. These have a wide range of soft colours which weather nicely and do not reveal patchy salt stains too obviously. Strong colours such as Ultramarine and Crimson Lake have more pigment and less body and offer less effective cover. On the whole it is not advisable to paint an old building direct to the stone as a high level of residual salts left by years of evaporation will tend to discolour the paint or contribute to a breakdown in the bond between the paint system and the stone.

For joinery a distinction seems to be well established between the colours chosen for painting joinery in windows and doors to houses (whites with perhaps bright clean colour for the front door) and the doors and frames of outbuildings, warehouses and farm buildings – usually darker reds, blues and greens, perhaps likely to show dirt less. This distinction should not lightly be ignored. Brilliant White, so popular with the DIY trade, can be very harsh and alternative soft whites, creams and soft greys do work well with honey coloured stone and brick of this area and these colours will provide a little relief to the dark whinstone of Craster or the redder sandstones of Bamburgh. The use of wood stains for new work is acceptable but will not protect traditional glazing putties. It is usual in this context to use timber glazing beads pinned over an appropriate glazing compound.

The Building Regulations do recognise the sensitive issue of working on historic buildings including specifically '*buildings of architectural and historical interest within National Parks, Areas of Outstanding Natural Beauty and World Heritage Sites*'. Building Inspectors will '*take into account the advice of the local planning authority's Conservation Officer*' particularly where work relates to '*restoring the historic character of a building that had been subject to previous inappropriate alterations e.g. replacement windows, doors and rooflights*'. In such work the aim should be to improve energy efficiency where and to the extent that it is practically possible always provided that the work does not prejudice the character of the historic building. The footnote on historic buildings also makes the important point that, the 'biology' of an old building is different from a modern structure and encourage '*making provision to enable the fabric of historic buildings to "breathe" to control moisture and potential long-term decay problems*'.

Vehicular Access and Garaging

The position of vehicular and pedestrian access to a house will depend on the site frontage and be subject to advice provided by the County Highway Engineer. Within the site itself the layout of drive and hard-standing will depend on the relationship between garage and house. There will generally be a preference for attaching a garage to the dwelling as a subsidiary volume to it rather than it being a free-standing structure. This will allow direct connection under cover and will presume upon an extension of the same materials and form of construction as the house.



Recessed garage door as part of a building



A group of attached garages in same material as housing



A garage might be an extension in the form of a ridge and gable at a lower level as shown left, or a simple lean-to – however in this example two doors rather than one large would have been more appropriate as the lintol appears structurally unconvincing

Where permission is granted for a free-standing garage the construction should be in keeping with the surrounding buildings. The use of "off the peg" kit structures or flat roofed boxes will not be acceptable.



The impact of the larger garage doors, particularly the two-car up and over type, can sometimes be very much out of scale with other openings in the building. If possible it is better to have two separate doors with a pier or column between them.

There is a wide selection of garage doors of different construction and types of operation. In the AONB reticence in character and colouring will be favoured: the door leaf should have the appearance of vertical timber boarding, and indeed preferably be genuinely so. The pressed steel panel types are clearly false and inappropriately pretentious.



This three storey building can cope with the insertion of multiple garage doors



Pressed steel or fibreglass doors look incongruous

Conservatories and Sun Rooms

Free standing conservatories and greenhouses as structures within the garden will require careful consideration of siting and orientation in the garden plan to avoid being intrusively conspicuous to neighbours or the public, but the conservatory attached directly to the house present much greater difficulties of design.

The assumption must be that the conservatory will be placed where it has advantage of the sun at some period of the day: it may double up as an entrance to the house or as a breakfast room, as a place for flowers or for children's toys and tricycles. All these considerations must be taken into account as well as the very proper concern about the visual impact of the new structure on the character of the home and its neighbourhood. The introduction of minimal heating into a conservatory to protect plants from frost may be justified but the assumption is that the orientation of a sun-space will ensure the maximum benefit of available passive energy. In this respect a conservatory must also satisfy the requirements of Part L of the Building Regulations.

Though it might be entirely appropriate for the Victorian and Edwardian villa of Alnmouth or for the more substantial farmhouse in the AONB the larger conservatory will often be too elaborate for the simpler house or cottage even if garden space is available. However there is now a wide range of small to middling size conservatories on the market which have become popular. Most of these are based on a kit of components which can be developed into various forms of lean-to or ridge construction, and are manufactured in a range of materials some of which may not be wholly suitable in a salty coastal situation but from which a choice can be made to relate to the location.

All the recommendations already made in relation to extension may equally apply to the siting, size and design of conservatories. There are of course special considerations to be taken into account here because a glass building is vulnerable to heavy falls of snow off higher roofs and can make access difficult for cleaning higher windows or general maintenance. Thus there will be some practical preference for siting a conservatory at a gable end of a house either as projecting ridge type or as a lean-to.



A modern conservatory with two glazed sides and half glazed roof fits neatly at the end of this house



Dwarf walls for a conservatory should be built in the same material as the main house

Here a screen wall is shown which ties the conservatory in to the house and provides a warm surface against which to train plants



I

In some cases a garden room extension may offer better all year round use if it has an insulated slate or pantiled roof rather than glass. As the roof would then be a non reflective surface perhaps of the same material as the house roof, the extension would become easier to integrate with the existing building and the glazing of the walls could reflect the domestic fenestration more clearly.

Oriel and Bay Windows and Balconies

Even on days when the sea is rough and the wind too strong to venture out, a view of the waves and the ceaseless activity of the shore-line can be endlessly fascinating. Many houses in villages along the coast have gained views of the sea, often only a sidelong glimpse down a lane, by the addition of an oriel or a bay window.

Where these were conceived as part of the original design most integrate well with the main body of the building (Alnmouth and Seahouses 19th and early 20th century villas for example). Charming oriel windows, projecting above ground floor level leaving clearance for pedestrians below, add a flourish to the frontage while more solid bay windows, projecting at ground floor level and sometimes rising though two floors on the same plan, give an air of prosperity to the villa type of house. Some of these are crowned with elaborate cast-iron balcony railings.



More recent examples have been less successful: Beadnell has a plethora of extensions in the form of bay windows, clumsily detailed and poorly integrated, often with a balcony above, which seem little used because so exposed.

Oriel windows should be delicately designed to reflect their structural relationship with the wall from which they project: they must be lightweight and are usually quite shallow to avoid excessive intrusion on the street. Bay windows can be more robust since they develop their structure from ground level foundations and they can be larger if the property frontage has anything of a garden before it.

Both oriels and bay windows will tend to have more glass than the adjacent windows in the wall of the house and may come to dominate the elevation. It is possible to break the dominance down by subdivision with transoms and mullions to relate the sizes of window openings across the frontage.



A drawing indicating how not to do a variety of extensions and alterations

Shop front design

Most villages in the AONB have seen a resurgence in retail enterprise with the growth in tourism, and the small village shop is not the only retail activity. The provision of services to tourists is an attractive sector for energetic young people to enter or for those in early retirement still with energy to display. However few shops are new built and most of the retail activity takes place in buildings altered, converted or extended for retail purposes.

The alteration can present problems of respect to the scale and character of the original design and for the wider context. To some extent this tension is the product of a desire to be seen and noted – advertising thrives on competition and the 20th century saw an explosion of retail showiness. But with this also comes a tendency to think of cheap/short term investment with rather little concern for quality.

Local Authorities are increasingly concerned at the disastrous effect of brash modern shop-fronts and signs on the character of town and village centres and are calling for a degree of reticence and respect both for the buildings in which shops are located and for the interests of neighbourliness.

They are also concerned to protect original components of older shop fronts. Often apparently recent shop-fronts contain hidden original detail in sufficient quantity to enable accurate restoration or incorporation in sympathetic design. In such cases restoration can result in the recovery of a balanced relationship between shop front and the whole building frontage showing off the undisturbed character of the upper floors to the general gain of the streetscape.

Both Alnwick District Council and Berwick upon Tweed Borough Council have written special design guidance leaflets for shop fronts which are available from Council Offices and through the AONB Team.

The Planning Authorities believe that the promotion of design guidance for the retail sector in the AONB will have the following benefits :-

- A general up-grading of the village centre environment which the whole community can enjoy.
- An individual benefit to each enterprise in improved showcase of merchandise.
- A general sense of confidence in the focus on a vibrant enterprise culture good for the local community and good for visitors too.
- An enhancement of the lifespan of each property by planning maintenance.

The Planning Authorities are taking a lead in encouraging change as they believe that it will benefit both traders and the AONB communities.

To shop-owners we say

'Be willing to change.'

If your shop front is your showcase it needs to speak well of you'

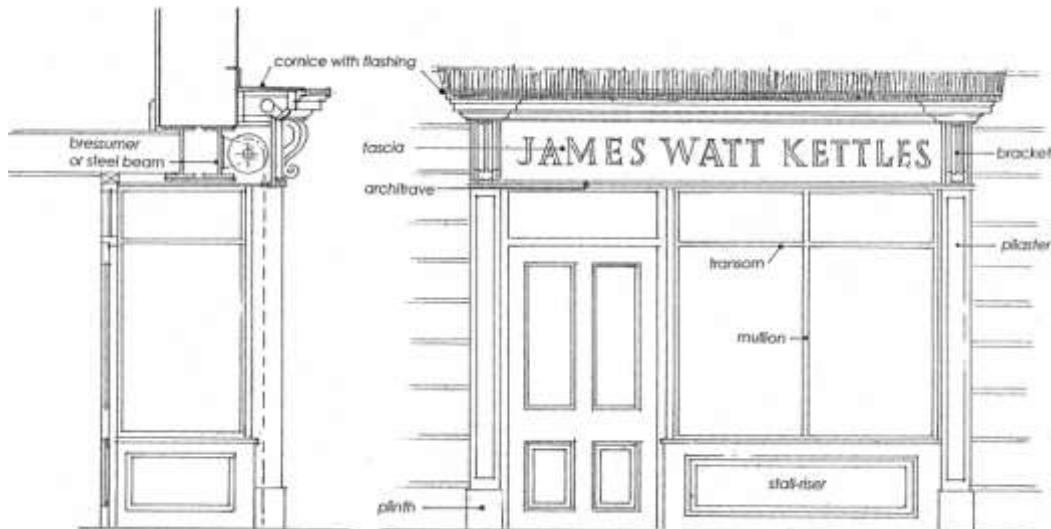

Principles for Action

1. The shop front is a component in the whole street and should therefore be considered as part of that context, sympathetic to the architectural character of the adjacent properties.
2. The shop front is not the only component of a property or even the most significant. The design of the shop front should respect the proportions and scale of the frontage as a whole.
3. Where one shop occupies two or more buildings of different character it may diminish the value of each to spread one shop front across it all. Better to respect the identity of each in the design.
4. Traces of old shop fronts are rare and valuable. In making alterations to apparently modern fronts always look for hidden older components, record them and if possible retain them in the new design adding appropriate materials and details to allow their conservation.
5. Existing out-of-character shop fronts should be seen as temporary intrusions failing to achieve the standard of good design in the contexts. Plan for their removal and replacement with designs and materials that reflect the higher standard aimed at today respecting the character of Conservation Areas and village centres.
6. Where no original design or detail has survived a modern solution will be the most honest approach, but a high quality traditionally detailed design may well be appropriate. The quality of detail is crucial to the execution of new work.

Disabled Access

General guidance and references to regulations and legislation which covers provision for disabled access are shown in **Accessibility for All**.

A summary of the likely points that can be expected to be relevant to alterations and extensions is given below:

Disability Discrimination Act 1994 (DDA)

Imposes a duty of those providing services to the public to ensure that the service are as readily accessible to disabled people as to others. Since 2004 it has been required that service providers make reasonable adjustments to the physical features of their premises to overcome barriers to access. The provider and designer should consider the following:

- **Car Parking** : Adequate space, suitable surface, disabled marking if reserved.
- **Paths** : Distinct separation from vehicular routes, suitable surface, dropped kerbs, appropriate width, unobstructed passage, handrails on slopes steeper than 1 in 20.
- **External Signs** : For clarity, well lit, location, logical sequence.
- **External Lighting** : Avoid contrasts and pools of darkness.
- **Street Furniture** : Avoid obstructing movement.
- **External Ramps and Steps** : Gradients, lengths, landings, handrails, lighting.
- **Entrances** : Adequate space for manoeuvre with door swings, threshold levels. Door operation, handles, closers, automation.

For all these issues refer to **Accessibility for All** for further discussion.

Building Regulations

Part M applies generally to new work to domestic property and to buildings where access is intended for the public. It is very likely that the regulations will be up-dated from time to time but their operation cannot be applied retrospectively. Nevertheless alterations requiring Building Regulations approval will have to comply with the provisions of Part M.

Sustainability

The alteration and extension of existing buildings to provide accommodation relevant to today's way of life is a fundamentally sustainable process continuing the habit of previous generations in making good use of space available to us. The land, building structure and many of the old materials are likely to be reused which reduces the volume of new resources consumed and the volume of materials for disposal. The use of reclaimed materials will result in a significant reduction in the embodied energy of the project. Designing for durability to reduce the amount of maintenance required also helps to control future consumption of resources. A fuller discussion of the efficient use of resources and of other aspects of designing for sustainability is contained in **Sustainable Construction**.

Bats and Birds

All British Bat species are given special protection within England by their inclusion in Schedule 2 of the Conservation (Natural Habitats) regulations 1994 and Schedule 5 of the Wildlife and Countryside Act 1981. All wild birds their nests and eggs are protected by law.

Minor alterations or extensions to existing buildings may not necessarily affect bat or bird habitat but many schemes, particularly those affecting roofspace, must be assessed by survey to establish the likelihood of the space providing a suitable habitat for bats. Similarly old masonry walls may prove attractive to hole-nesting birds. A licensed surveyor may include recommendations for mitigating action to ensure the continued availability of suitable habitat after alteration or extension. Advice on what steps to take can be sought from Natural England, North East Office.



Northumberland Coast AONB Design Guide for the Built Environment

Conversions



The conversion of existing buildings usually follows redundancy in their original function where a new economic use is hoped for (whether it be light industry, craft workshop, residential or holiday lettering). Local Authority Local Plans (Local Development Framework Documents) have a number of policies on the issue of conversions and planning applications will be judged against these policies. The AONB Management Plan includes

Policy LP8

'In conversion of structures into new uses, including dwellings, ensure that any alterations to their setting do not detract from the rural character or local distinctiveness and, that the character of the building itself remains intact'.



In relation to design matters the underlying policy objective is to protect and enhance the character of traditional buildings in the AONB, whether farm buildings or granaries warehouses and workshops associated with maritime trade through the small harbours of the coast. This appearance and character is best safeguarded by retaining the original use or a closely related function, but where that is no longer possible the proposed conversion should at least retain the original 'feel' of the building. This may not be a great challenge where the intended function is not far different in the use of existing spaces within the structure. It is more difficult where conversion of simple large space is to residential use where many smaller spaces are expected each with its own need for access and daylight or a view out. It is unlikely to be acceptable to make alterations or to extend a traditional barn or byre if in the process its external character is lost in a welter of dormer windows or rooflights, a fussy porch and conservatory or picture windows. These things are not part of the plain functional character of the traditional farm building and if substantial extension or the construction of new outbuildings appears necessary in the first place the view may be taken that the proposed conversion is unsuitably ambitious.

In addition, the proposed use must be compatible with its surrounding uses and must not of itself generate further development, for instance replacement farm buildings, which would detract from the character of the converted building and its setting. In the case of old farm buildings on an active farm, consideration must also be given to the impact of the continuing farm operation on the amenities of the new conversion.

“A supportive approach to farm diversification should not result in excessive expansion and encroachment of building development into the countryside.”

**From Planning Policy Statement 7:
Sustainable Development in Rural Areas**

Pointing and masonry repairs

It is quite usual to find the condition of the stonework in redundant buildings somewhat neglected. Repointing and masonry repairs may be necessary to consolidate the structure and make it sound for its new life. Very often the failure of a roof covering will mean that water has entered the wall head and the cycle of wetting and frost can weaken the top courses of stone. So too at the base of the wall damp can affect mortar and ground levels may need to be adjusted to cover footings. It is unlikely that old farm buildings will have had deep trenches excavated for foundations but many buildings of this type have quite shallow footings of large stones which may need sectional underpinning with concrete. Old warehouse buildings will tend to have been more robustly built with deeper foundations to carry heavier loads.

In some older buildings the face of stonework may have been weathered back in a way that leaves flakes of stone only loosely attached to the wall. These should be brushed or picked off, since they will fall off in due course anyway, and the wall left in sound (if weathered) condition. Individual stones that have become so worn away as to threaten the structural integrity of the wall can be cut out and a new matching stone built in or a section of stone neatly cut out and a new piece indented. This is work better done by a skilled mason and needs a fair amount of precision.

Repointing is only necessary when mortar joints have perished and the mortar is breaking down losing its structural integrity. Some very strong cement-based mortar causes trouble to sandstones which decay behind it. When walls get wet the moisture they absorb moves if it can to the mortar joints from where it evaporates. Traditional lime mortars allow maximum breathability and they don't crack as a result of building movement or temperature change. Hard cement-rich mortars are much less forgiving and tend to trap moisture which through the action of frost and the concentration of salts accelerates the decay of the stone. It is always better to ensure by the deliberate choice of a mortar weaker than the stone that in the long process of weathering it is the pointing that is sacrificed not the stone. With the hard dense whinstone, typical of Craster for instance, the mortar should remain relatively weak as the evaporation will only occur through the mortar since the stone is impervious.

Where re-pointing is needed the existing mortar should be raked out using hand tools only to a minimum depth of 30 mm. The prepared joint should then be cleaned with a stiff brush and flushed out with a light spray of water. Advice from an architect or building specialist will be helpful in selecting an appropriate mortar mix. However in many instances re-pointing using a mortar consisting of 1 part of moderately hydraulic lime to 3 parts of sand or of one part cement to 2 parts of hydrated lime putty and 9 parts of sand should prove satisfactory.

Mortar will normally have an off white, cream or brown colour though in parts of North Northumberland the local sand may impart a red/pink colour. The preparation of a couple of sample areas using mortar mixes with different sands should help to ensure a good colour match. Allow the mortar to dry out for two days to reveal its true colour. By mixing concreting sand with building sand the mortar will more closely resemble a traditional texture with coarse aggregate



It is the stonework which should predominate (left) not the mortar (right)

Finishing the joints just behind the stone face allows the stones to “read” and generally produces the best appearance: it is also the least likely to cause long-term damage to the stone. The hard lines of raised “ribbon” pointing serve no purpose of benefit to the stone and have a rather aggressive appearance. In very poor random rubble masonry it is difficult to avoid buttering mortar over some areas of face but it is not good practice and can trap moisture behind mortar and damage the stone. The most pleasing results can be got by pointing the joints flush and then after the initial set stippling the surface so that it is slightly recessed and shows some of the coarse aggregate.

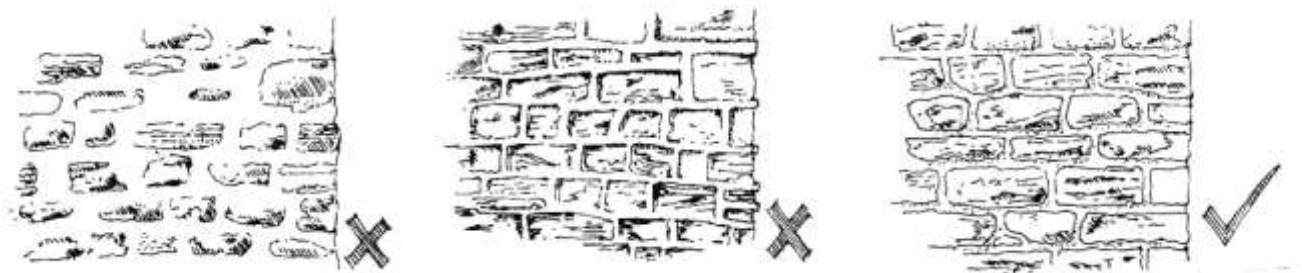

Render

It is typical of coastal settlements in Northumberland that a much higher proportion of buildings have a render finish over the structural walling material and the use of strongly coloured paints on render is almost a convention of maritime architecture. The severe exposure to wind, driven rain, spray and salts is a testing environment for any form of construction whether traditional or modern and practical experience of combating damp and decay is the common link behind decisions to render a building.

Early practice in the application of a shelter coat relied upon a lime and sand mix with a capacity to breathe. This would absorb rainwater to saturation point (any surplus tending to run off outside) and then release it by evaporation outward in an even way. A decorative finish of limewash (slaked lime stirred to a slurry and applied in quite thick coats) would be refreshed quite frequently; this too was part of the breathing shelter. Occasionally these protective coats have been removed in the interests of showing the stone only to find that dampness becomes a problem again. Even more substantial buildings such as Lindisfarne Castle may have been rendered though the practical problems of access to maintain this above its rocky plinth seem to have discouraged continuation of this practice. In spite of this difficulty The National Trust has recently re-rendered the North wall of the Castle.

Where renders are to be replaced a slightly stronger mix may be appropriate but, as with pointing, should not be stronger than the stone – a 1:1:6 (or 1:2:9) cement lime sand. Some textured renders are referred to as wet dash or rough cast. This involves the finishing coat mix which contains small pebbles being thrown against the undercoat from a casting or dashing trowel with a flicking action and being padded in for adhesion.

There are many proprietary renders on the market with a wide range of 'through' colour and texture. Great care is needed in their selection and use as many are inappropriately strong for the softer stones or lightweight blockwork now specified to achieve higher levels of thermal insulation. The design of the blockwork and render to include movement joints against early shrinkage cracking has to be taken seriously. The other problem (which may be a matter of taste) is that the aim of modern practice in rendering is to achieve a perfectly flat even surface with sharp mechanical details at corners and openings with little colour variation. This alone marks modern practice out as different in result for the softer modelling of traditional lime renders and the local authority may press the owner of a traditional building to pursue the traditional finish.

Roofs

Welsh slate and clay pantiles vie with each other as the dominant roof covering in the AONB. As slate is a more reticent surface and colour the general impression is led by the red pantile. Seen from approach roads or across surrounding fields the collection of roofs in a settlement reads as pantiles – red/orange contrasting pleasantly with the green of grass and tress. The pantiles work well with natural stone and render, slightly less well with brick where the proximity of colour between two manmade components can sometimes fail to excite interest.

While there is a ready supply of sound second-hand slates it is usually difficult to persuade a roofer to re-use old handmade clay pantiles because the irregularities created in the moulding and firing make it hard to ensure close jointing and many tiles stripped from older roofs prove to be chipped and flaked or have lost the hanging nib. So the selection of new tiles will look at hand-mades and machine moulded – noting the difference in cost – and probably choose a natural red clay pantile as the nearest approximation to the traditional roof covering – one that in time will weather to the familiar warm colour of the dominant finish.

Even with slates there is a natural diversity of colour and texture and as the market expands in imported Spanish and Chinese slates (which incidentally have a high indirect energy cost attached to them in the distance transported from source to consumer) this must be taken into account.

In the rare event of an old farm building already having been re-roofed in profiled sheet form, the opportunity of conversion could be taken to restore the roof to natural slate or tiles, though the structure may have to be checked to ensure that the additional weight can be carried. In some cases however modern fibre-cement profiled sheeting which has superseded asbestos cement and can be obtained with a through-colour makes an attractive and acceptable alternative.



Rainwater disposal and waste pipes

The simple character of farm and warehouse buildings is maintained in the details of guttering, typically cast iron half round gutter supported on drive-in brackets direct to the masonry without timber gutter boards. Adjustable drive-in brackets are still available and this form and material of guttering is preferred. The introduction of timber gutter boards and PVC rainwater goods may make the plumber's job initially easier and cheaper, but it is not as robust, is vulnerable to distortion and snow slip and will not last as long. PVC gutters in the end become brittle with exposure to UV light.

If the conversion necessitates the introduction of foul water drainage then all new soil and vent pipes should be incorporated within the building (except where a vent pipe may have to appear at roof level). Only rainwater downpipes should appear on the outside.

Introducing daylight

Barns and other agricultural buildings and old warehouses are usually robust and strong in character, with stone walls, slate or pantile roofs, simple door and window openings, the windows often associated as much with ventilation as with light. Typically the doors and window frames are painted a dark green, blue or red or are stained black.

The developer should try to retain this essential reticence of character in the conversion. The existing openings should be used where possible (there are often former openings blocked up which can also be re-opened usefully) and external structural alterations should be kept to a minimum.

Fitting an internal upper floor in the traditional barn is often attempted and presents common problems. The roof structure may need to be adapted to avoid obstruction to movement along the upper floor. In such cases it is advisable to have a structural engineer's professional advice to avoid weakening the structure.



A sensitive but contemporary barn conversion

The principal difficulty of introducing an upper floor in this way is how to handle the windows that will be required for natural lighting and ventilation. Dormer windows will not be an acceptable introduction to converted farm buildings and if the character of the existing building is not to be seriously affected it will probably be necessary to accept lower standards of lighting. Often a small central window in a gable end might be successful and the alteration of the low level ventilator openings to become windows close to the upper floor level will provide a spread of subdued light across the floor. The Planning Authorities will however consider seriously bold attempts to bring redundant farm buildings into use for certain types of function which require high levels of natural daylight, by incorporating long strips of glass along ridge or eaves, a glazed slot just behind a gable or a sympathetic insertion of conservation type rooflights.

Alternative ways of handling more extensive rooflighting

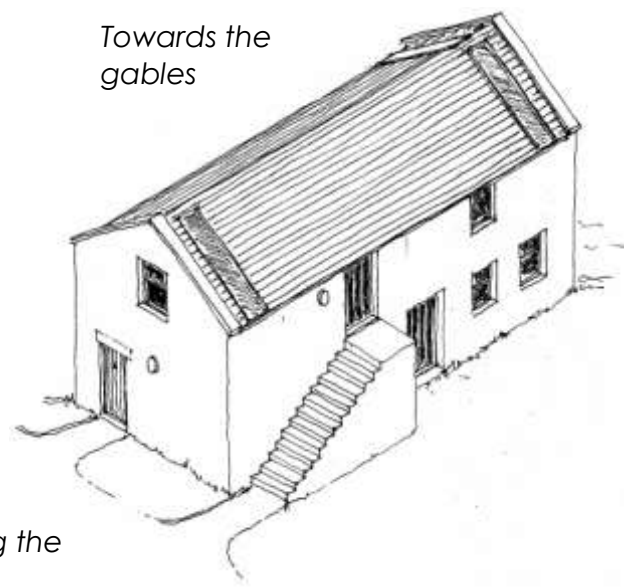
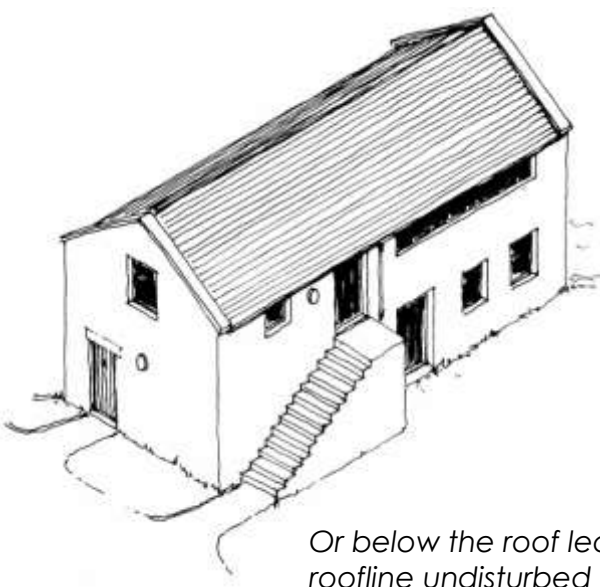
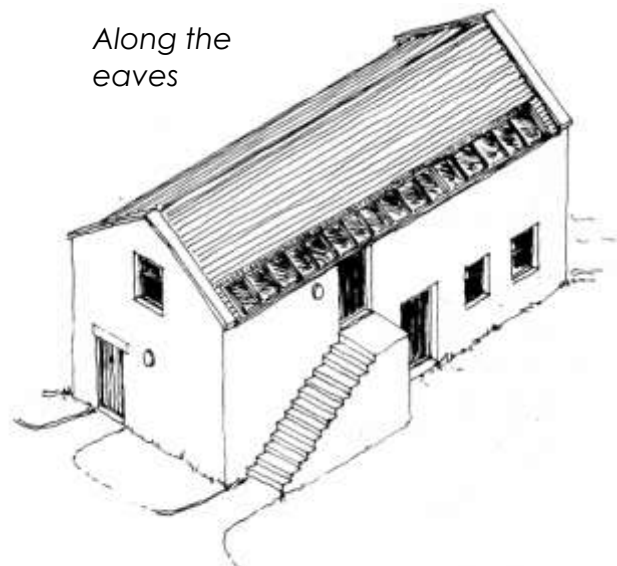
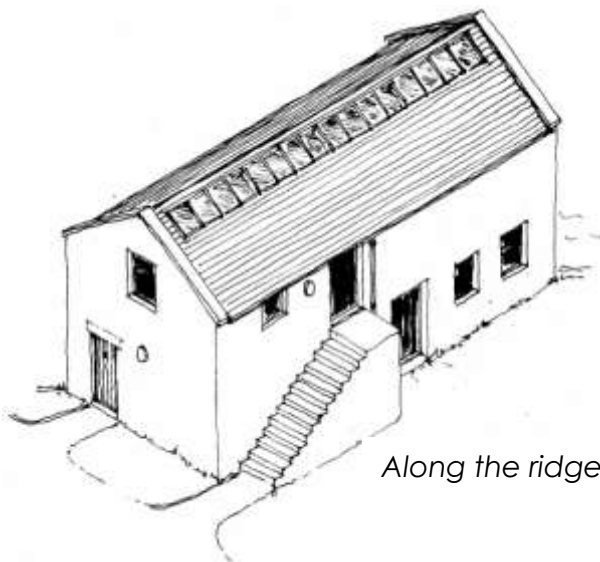

Windows, Doors and Screens

Windows should reflect the character of the redundant building and certain types which suit modern housing might be unsuitable in this context. It is expensive and unnecessary to hack away at existing openings to make them the right size for standard off the peg windows when new windows can be purpose made at less expense to suit existing opening sizes.

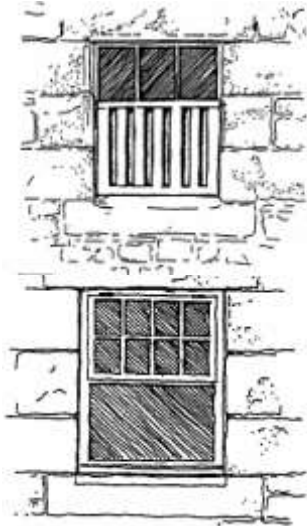

Many farm buildings have glazed lights associated with hit and miss ventilators or inward opening hopper lights above fixed glass. These might serve as models for new timber windows adapting the scale of the sub-division, as in the examples that follow.

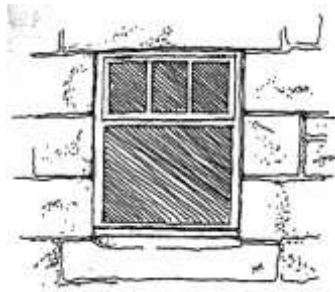

These could be top hung casements or hopper inward opening

In most of these models the detailing would be finer with single glazing but as we move towards a situation where double glazing becomes the norm for new windows, some thickening of the glazing bars becomes necessary and certainly more acceptable than the fussy (and essentially false) strips of timber or worse still of diamond leaded lights. In historic buildings multi-pane windows will need to be single glazed to retain traditional slim glazing bars.

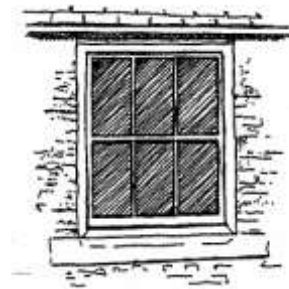

A six light pivot window

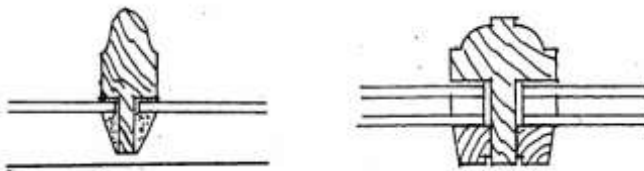

Traditional single glazing detail on the left with an acceptable solution for double glazing on the right

In some cases plain uninterrupted glazing is appropriate, particularly where the frame is painted or stained dark because this gives an unfussy reading of the original opening.

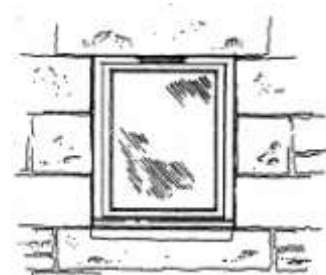

Windows and door frames in barn and warehouse conversions should be decorated in darker colours to reflect the origin of the building. In this respect it is essential to record the existing colours of the barn and adjacent buildings.

Retain old ironmongery wherever possible. Modern door furniture rarely has the character or substance of the handmade original

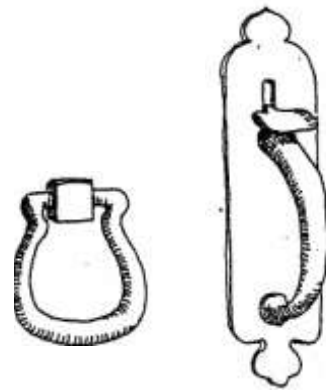

Existing doors are unlikely to be sufficiently weather tight to be retained unchanged. Often the door leaf is hung direct with strap hinge and hook to the stone rebated surround, with a ring handle or robust thumb latch and bolts.



In most conversions the door will follow the typical boarded pattern of the original doors, though glazing is often absent in the original. A simple glazed opening occupying about a third of the width of the leaf or a glazed overpanel will retain the character of the building.

Large openings such as hemmel arches and barn doors offer an opportunity for bold division in glazed screens with dark painted or stained timber so that from middle distance the opening reads as more important than the frame.

Sub-division of the frame looks better if in thirds or fifths rather than half or quartered, so that an entrance door might be central. This feature is derived from the most ancient classical precepts placing a void at the centre not a post or column. There is always a problem of safety in large sheets of glass filling openings from floor to lintol – a risk particularly of children running into the unprotected glass. For this reason it is usual to introduce a rail at about 800 mm from the floor with toughened glass below the rail.

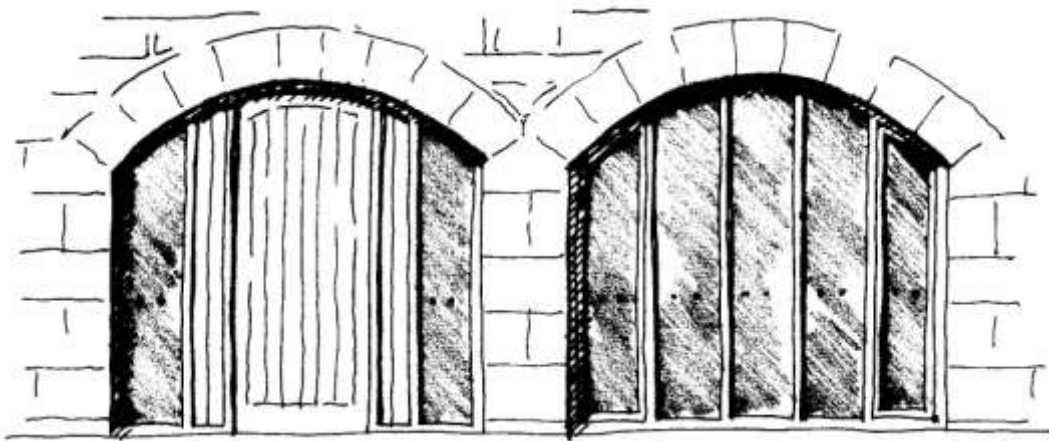

An example of infill to a pair of hemmel arches

The screen in this case should be set back in the inner plane of the wall to show as much depth externally with full modelling with shadow in the arch. In this connection it is generally unsatisfactory to build new "hemmel" arches in thin cavity walls because the shallow reveal is given away.

These recommendations all confirm that the simple robust character of existing farm buildings and warehouses proposed for conversion should not be diminished by the addition of elements that would have no place in the original. Porches and conservatories do not come into the vocabulary of such conversion but it may be possible to achieve the benefit of a porch/draught lobby by internal sub-division rather than as an extension.

Chimneys/Flues

The position of chimneys and flues will be affected by internal planning, but would in the case of barn or warehouse conversion be preferred as an insulated metal flue rather than a masonry chimney.

In the case of craft or light industry use there may be rather conspicuous ventilation extract cowls or heat exchange plant required for the operation. Where possible the bulky plant should be housed internally or sited on the least visible elevation of the building.

Avoid flues and extracts breaking the line of dominant roofs. Flues should be stove enamel dark colour



Roof ventilators

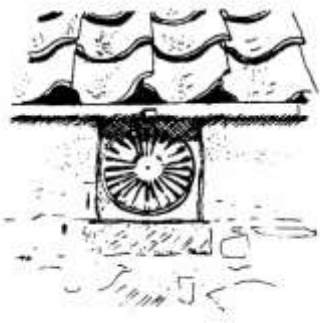

It is a common feature of barns and cattle byres to have provision for adequate ventilation at eaves and ridge. In many instances this was achieved with attractive cast iron ventilator grilles and special ridge tiles. Because these original features contribute to the character of a building and because ventilation will still be required even if the building is converted to another use it is worth trying to retain these details.

Painting

Except where an established practice supports the painting of render or masonry with a lime wash or masonry paint it is expected that most converted buildings will be retained as the natural stone. A distinction is made between the painting of windows and doors to houses (long established as white or pale cream) and the joinery of warehouses and barns, usually a dark red, blue or green which would be less likely to show dirt. This distinction should not be ignored. Cream-greys and olive grey-greens go very prettily with honey coloured sandstones and Venetian Red/terracotta with the redder sandstone of North Northumberland. The dark whinstone of Craster might need a little relief in cream-grey paints. The use of wood stains for new work is acceptable but will not protect traditional glazing putty. It is usual in this context to use timber glazing beads pinned over an appropriate glazing compound.

External Areas

In relation to the setting of the newly converted building the Planning Authorities will seek to ensure that a new dwelling has a satisfactory provision of curtilage, the opportunity for a private garden and adequate car parking. If the proposed use is commercial then the traffic generated by that enterprise and the need for hard-standing and external work areas must be fully identified. In all cases proposals for lighting, paths, boundary walls, fences and planting should be shown in the planning application. In another section of this design guide the detailing of external works may be found useful. Link to Landscape.



Where two or more units are to be created from the converted building common treatment of external spaces is preferable: external sub-division can easily destroy the unity of a building.



Lighting

Property developers should manage external lighting for conversions to reduce waste energy; ie. electric lighting shining where it is not needed either into the night sky or into neighbouring property. Bright light shining into other peoples' homes can reduce their quality of life and environmental Health Officers may need to intervene if your neighbour complains about unnecessarily bright lighting. (CPRE "Night Blight" 2003).

Light fittings have become something of a fashion accessory but for most external rural/village purposes a simple drum or brick shape bulkhead light fitting not exceeding 150W output is more appropriate than an elaborate reproduction coach light or 'gas lamp' fitting. Many have louvres or cowls which prevent misdirected light. Bracket fittings holding a shielded lamp are also satisfactory. Also, of course, the conservation of energy can be achieved by installing control systems that switch lighting on when it is needed either manually or automatically and then turning off after a sufficient lapse of time.

Two Case Studies

This amusing and daring conversion by a German architect of a small ruined pigsty with storage above leaves the original structure in its dilapidated state, neatly fits an inserted cell inside the walls (windows and door openings carefully measured to correspond with existing openings) and extends the roof to protect the tops of the old walls. Presumably costs are kept to a minimum since there is little work to do on the existing structure.



Conversion of farm buildings into workshops and office space at Hawkhill Farm.



Other Issues to be Considered

Bats and Birds

**AONB Management Plan Policy LP9:
Assess all conversion applications for potential impact on bat
roosts and hole nesting birds and ensure appropriate spaces and
access are retained.**

All British Bat species are given special protection within England by their inclusion in Schedule 2 of the Conservation (Natural Habitats) regulations 1994 and Schedule 5 of the Wildlife and Countryside Act 1981. All wild birds their nests and eggs are protected by law.

Surveys to establish the presence of bats and wild birds in existing buildings and to assess the likelihood of the building providing a suitable habitat for them must be undertaken by the proposing developer. The licensed surveyor will also include in a report recommendations for mitigating action to ensure the continued availability of suitable habitat for protected species.

The local planning authority cannot grant permission for development without being satisfied that protected species are being protected and that mitigating measures are in place. The planning authority or Natural England will advise the developer of the action to be taken in this regard. The conversion of redundant buildings will always entail consideration of protected species.

Sustainability

The repair, alteration and conversion of existing buildings to provide accommodation relevant to today's way of life is a fundamentally sustainable process continuing the habit of previous generations in making good use of space available to us. The land, building structure and many of the original materials are likely to be reused which reduces the volume of new resources consumed and the volume of materials for disposal. The use of reclaimed materials will result in a significant reduction in the embodied energy of the project. Designing for durability to reduce the amount of maintenance required also helps to control future consumption of resources.

A fuller discussion of the efficient use of resources and of other aspects of designing for sustainability is contained in a separate section **Sustainable Construction**. This is an important and far reaching issue and includes consideration of the following:

- Re-use of buildings and land
- Minimising energy in construction and use
- Water and drainage
- Renewable energy
- Social and economic sustainability
- Pollution
- Biodiversity
- Minimising waste

Access for disabled people

General guidance and references to regulations and legislation which covers provision for disabled access are shown more fully in a separate section of this Guide

Accessibility for All.

A summary of the likely points that can be expected to be relevant to alterations, extension and conversions is given below:

Building Regulations

Part M applies generally to new work to domestic property and to buildings where access is intended for the public. It is very likely that the regulations will be up-dated from time to time but their operation cannot be applied retrospectively.

Disability Discrimination Act 1994 (DDA)

Imposes a duty of those providing services to the public to ensure that the service are as readily accessible to disabled people as to others. Since 2004 it has been required that service providers make reasonable adjustments to the physical features of their premises to overcome barriers to access. The provider and designer should consider the following:

- **Car Parking** : Adequate space, suitable surface, disabled marking if reserved.
- **Paths** : Distinct separation from vehicular routes, suitable surface, dropped kerbs, appropriate width, unobstructed passage, handrails on slopes steeper than 1 in 20.
- **External Signs** : For clarity, well lit, location, logical sequence.
- **External Lighting** : Avoid contrasts and pools of darkness.
- **Street Furniture** : Avoid obstructing movement.
- **External Ramps and Steps** : Gradients, lengths, landings, handrails, lighting.
- **Entrances** : Adequate space for manoeuvre with door swings, threshold levels. Door operation, handles, closers, automation.

For all these issues click on [Accessibility for All](#) for further discussion



Northumberland Coast AONB Design Guide for the Built Environment

New Building



New Housing

Pressure for development in the AONB settlements grows and demands increase generally for new rural housing in the region. Planning policy aims to protect open countryside from sporadic development and proposals for new houses for farm or forest workers have to demonstrate the economic viability and functional need of the enterprise to justify approval. There is more scope in the settlements for further development but the planning authorities want to ensure that growth is used to achieve good quality housing to meet local needs and to enhance the rural landscape and natural heritage of the AONB.

"Affordable rural housing should reflect, support and enhance local character and continue a tradition of good ordinary dwellings in the rural landscape"

The Prince of Wales: Affordable Rural Housing Initiative 2006



In Northumberland the best rural housing of the past has been the product of the larger landed estates providing accommodation for the considerable number of employees needed, in the 18th and 19th centuries, to run farm, quarry or woodland operations typical of rural enterprise. Planned development of estate villages or infill to existing settlements took the form of terraces of cottages balanced by the occasional larger house (perhaps for the Agent or School Master). These developments were initiated in 'enlightened self-interest' to satisfy functional need.



With the 20th century social and economic change led first of all to a dramatic decline in the rural labour force, then a sharp rise in the demand for second homes in attractive areas like this AONB and an increased ability of those working in nearby urban areas to buy property in the country for permanent residential use while commuting to their place of work in the towns. High house prices coupled with low rural incomes now mean that many local people are unable to afford a home to buy or rent in the community in which they grew up, have family or work.

In amongst this is a vision that diversification in the rural economy will create jobs for younger people to maintain their place in the community if they wish. Also at the other end of the social spectrum that the elderly (those least ready to meet change late in life) would be provided appropriate accommodation at the heart of their native settlement within reach of simple services which would be shared with neighbours and family: tea room, hairdresser or village shop.

**AONB Management Plan Policy LP10:
Support efforts to secure provision of adequate affordable housing in the AONB where there is a demonstrated need.**

How can rural housing be provided?

The need for affordable homes is increasing. Some provision can be made by adapting or converting under-used or empty property or space above shops. Issues surrounding the design of such conversions are referred to in an earlier section. Undoubtedly the assembly of land for new housing is more difficult. The steady procurement of small sites, infill, re-used Brownfield sites, the replacement of dilapidated units or earlier 20th century housing which cannot be upgraded to meet today's standards of sustainability and energy efficiency; all this activity has to compete in the open market with private buyers and speculative developers, who will cherry-pick the best sites.



These two photographs show no thought to local character and an extravagant use of village edge land

Deliberate planning intervention to ensure that a particular provision is made for say sheltered housing at the heart of a settlement will become easier with the Local Development Framework structure of policy making, but smaller scale development could permeate the fabric of AONB settlements achieving density, proximity, shelter and a sense of community very much in tune with the established character of the settlements. This kind of 'consolidation' will help to ensure the 'critical mass' needed to support rural services – shops, post office, public transport and school – in a word bringing economic viability and social sustainability together.



An intimate courtyard scene retains shelter and the density of the village



High density new housing near Perth

How is new development to be integrated?

The key to good integration must lie in careful consideration of siting, scale, form and massing as well as sensitive selection and use of materials. The sites available for affordable housing will relate to historic land holding patterns. They often provide the opportunity to complete or extend a traditional arrangement of houses in terraces developed over time along main streets or back lanes confirming the compact layout of the settlement in a way that much suburban sprawl of the 20th century has wilfully ignored.

A good example of a successful infill development can be seen at 3 Harbour Road, Seahouses.

The civic aspects of design will take account of the public impact of a building in its setting and the interests of adjacent owners – avoiding overlooking their private space or obstructing their established views. The inspiration for new design can come from older forms of building and the use of local salvaged material without slavish imitation but today we are likely to be guided increasingly by concerns about energy conservation and new technology and aware that in some cases it might be environmentally detrimental to insist on local stone or timber or that traditional methods of construction will not meet current standard building regulations without modification.



Timber House



House in Alnmouth



Two bedroom house for rent at the Gleneagles Hotel

What is new housing to look like?

Good design is not just fashion or current taste; it informs the fundamental management of space, form and the use of materials. The mantra of 'form follows function' is a useful starting point in building design but it does not reflect the extraordinary breadth of expectation that householders may have of their homes. The private, social and civic aspects of building design must as far as possible be kept in balance: and designers will consider:

- how to create a sense of welcome
- how to exploit the best views
- how the house relates to street and garden
- how the motor car can be designed 'in' rather than left as an afterthought to clutter the public space
- how to maximise shelter and how to exploit passive solar gain and other environmental benefits
- how to ensure durability, low maintenance and long-term sustainability
- how the three dimensional relationship of planning can be sustained particularly relating to stairs and circulation, as well as plumbing and drainage
- how the cook can be sociable while providing food



Contemporary interior



A simple barn like structure reflects traditional scale with contemporary management of space and materials

New methods of construction allow freer space planning, larger openings and a different relationship with the ground. There are many ways in which housing built with modern materials can fit well into the context of older buildings. As it happens in the AONB render is already well established as a finish for walls, timber is found in much coastal construction including boat building and the traditional chalets of the sea frontage. Modern machine formed pantiles and profiled sheet maintain the form and function of traditional material in, perhaps from an environmental point of view, the most important component of buildings in the coastal settlements since roofs will be seen from outside the village envelope clustered together.



Timber framed home with barn like roof in profiled sheet and timber cladding



In certain contexts, though not familiar to us yet in this AONB, the Green Roof may be entirely appropriate – not needing great depths of soil to support a sufficient diversity of plant species and mosses. However the design and detailing of green roofs is not widely experienced in this country (one of Europe's earliest social housing schemes to have a green roof was in Malmo in Sweden in 1949) and will be affected by coastal conditions.

In harsh climates especially with wind-driven rain and spray the quality of weather excluding detailing can be critical. Recent publications on the use of timber cladding have demonstrated how it can be successfully used even in exposed coastal situations. Detailing doors, roof edges, windows and dormers all benefit from careful attention to weathering.



Deeply recessed windows are well protected from wind and rain



Roof edge detail



Costs

Affordable rural housing means 'affordable' not only to the occupant but to the manager/landlord and the community. All parties will have an interest in keeping costs under control.

“Although good design need not cost more there can be additional costs in using local materials and traditional crafts. But good design brings wider economic social and environmental benefits a legitimate community benefit for public investment enabling a better return on land value through higher densities and more imaginative use of space than most open-market developments can show”

The Prince of Wales Affordable Rural Housing Initiative 2006

New Farm Buildings



In the open low-lying farmland of the AONB scattered farmsteads form clusters of buildings with sheltering clumps of trees, perhaps a stock yard and garden walls running out into fences, hedges and drain dykes round the fields. The characteristic farm management has been to centralise the operation on the farmstead and there are relatively few dispersed field barns in the landscape.

The aim of the Design Guide is to safeguard the character of the wider landscape by encouraging the sympathetic integration of any new farm building into the existing farmstead. By focusing new development in this way certain practical advantages ensue of course: access roads already serve the farmstead, electricity and water are readily available; management, labour and equipment are already concentrated at the hub of the farm operation. So from the farmer's point of view the Design Guide can be seen to support the efficient planning of the enterprise.

Farm group viewed from the access road



... and the same group from above and behind



New farm buildings tend to be large wide-span, shallow pitched roofs of factory frame and panel components, rapid to erect and providing a cost-effective way of covering operational ground whether for livestock or storage. While the siting of a new building will be largely determined by the function to be performed, the massing and orientation should be considered carefully to minimise the impact on both the wider landscape and the character of the existing building cluster. It may happen that a dominant orientation of the larger traditional buildings including the farmhouse will suggest the alignment of the new building. Care should also be taken to ensure that the new building relates to existing buildings in scale. If a very large floor area is to be covered the new building could be handled as a multi-span structure to reduce its height and impact. Good ventilation can still be achieved for livestock with vents in every ridge and perhaps a higher central section with side aisles.

The scale of this row of sheds is close to the traditional, while allowing mechanised access to a large covered area



At the start of the process of designing a new addition to a farmstead cluster appropriate provision should be made for landscaping and planting to ensure sympathetic integration. If topsoil is stripped off the site of the new building it could be used to cover new banks to receive primary planting of screen trees and shrubs. You are encouraged to also read **Landscaping, Planting and External Detail**.

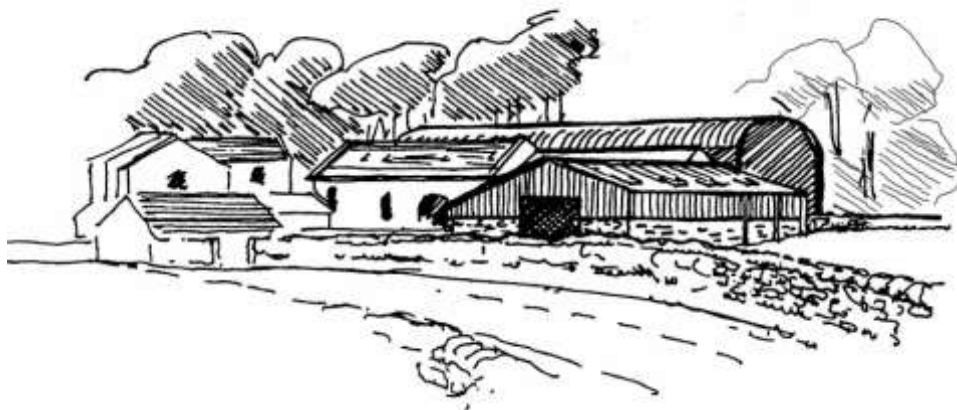

Materials and colour

In the longer views and across the AONB the impact of the roofs of buildings is generally more significant than that of the walls. The roofing materials likely to be considered for larger farm buildings will be profiled fibre-cement or sheet steel (always with a protective finish).

In clear weather the tones of both landscape and seascape along the coast are often quite light, while in winter greys are predominant in mist and sea-fret. In this context therefore lighter tones with a low reflectivity are preferable since the angle of the roof to the sky will make the roof seem lighter anyway.

Colours such as BS 00 A 05
 BS 12 B 19
 BS 12 B 21
 BS 10 B 21
 might be appropriate in the open
 while against trees a darker tone such as
 BS 12 B 25
 would merge better with the background

New Buildings for Tourism

Tourism has become a dominant economic enterprise in the coastal zone of Northumberland and many living in the AONB are involved in one way or another as service providers – accommodation, catering, shops, tour operators or local guides some with highly specialised knowledge of the natural and cultural heritage of the region. The quality of service they offer will be a lasting memory for those who visit whether as adults or children and may well stimulate return visits by those who come to love the area or make strong recommendations to their friends to visit too.



*Visitor reception
 at Alwick Castle
 Gardens*

Along with their experience of good service an important contribution is made by the quality of the built environment in which tourists are served. This is not so much the primary built heritage (the castles, churches, the terraces of Listed cottages or industrial archaeology) that they have included in their site-seeing, but the places of public gathering (the leisure facility, visitor centre or museum) that concerns us here.

In such a context the experience and expectation of the visiting public plays an important part. Today's visitor to Northumberland will bring his own experience of tourist facilities in many other parts of Britain or Europe and will judge our achievements by the standards found elsewhere. The tourist may not have travelled far but still might recall the excitement of discovering new visitor centres such as Fountains, Rievaulx or Whitby Abbeys in Yorkshire, in Cumbria the impressive extension to the Dove Cottage Museum in Grasmere – or even closer, in Northumberland, the newly completed Pavilion at Alnwick Castle Gardens.



*Visitor Reception
Fountains Abbey*



*The Jerwood Centre
Dove Cottage, Grasmere*

So the AONB Partnership has an interest in encouraging the highest standards of design for special projects of particular significance and will consider sympathetically alternative approaches to form and materials where the designer can demonstrate the need to extend the vocabulary of the built environment to respond to the particular conditions of the brief.

Projects of this type will be reviewed by a panel of experts in consultation with the planning department and will still be measured against the **Design Criteria** drawn out from the discussion in that section of this Guide.

But alongside these special projects are many more buildings which set the tone for the visitor's experience: the Bed and Breakfast, Self-catering cottage, café or restaurant, public house or hotel; all these have a contribution to make. Particularly where first time conversion from a redundant building or associated new build is involved the highest standard might be the aim and the design should seek to bring out the best of the character of the original building in the new work. The standards of provision set by the Regional Tourist Board are not specifically design orientated but require certain facilities to be included to achieve the various categories of accommodation. How these are presented is a matter of design and of sourcing quality equipment which may take that much more effort and care to track down. Often the assembly of furniture, cutlery and linens can make a significant impression.



Interior views of kitchen and bathroom to holiday cottage at Rievaulx, N. Yorkshire. A high standard in fitting out is maintained creating a favourable impression

Lighting

Property developers should recognise that light pollution (ie. electric light shining where it is not needed) is everybody's problem, including theirs, and that they can manage external lighting for new buildings to reduce waste energy and light trespass. Northumberland is rated as having the lowest level of light pollution of the England Counties and many visitors remember seeing bright stars and the Milky Way in our dark night skies. (CPRE "Night Blight" 2003).

Bright light shining into other people's homes can reduce their quality of life. Environmental Health Officers receive complaints about loss of sleep and loss of privacy with badly diverted or unnecessarily powerful floodlighting or security lights. Developers should avoid the strong 300- 500 Watt lighting for housing purposes. The Institute of Lighting Engineers recommends 150W as an adequate maximum. For most rural purposes a simple bulkhead light fitting is more appropriate than an elaborate reproduction 'gas lamp' or 'coach light' fitting. Many lights have louvres or cowls as an option which prevent misdirected light. Bracket wall or corner lights holding a shielded lamp are also satisfactory.

For public buildings, for tourism or commerce, or for the presentation of historic buildings or monuments, a higher level of illumination may be appropriate. Here the services of a Lighting Engineer could help identify the purpose of lighting and the target features to light (still with the object of avoiding waste), and advise on the positioning, choice of fittings and colour of lighting.

Public Policy Initiatives

Rapid and constantly developing public policy on the conservation of energy, the search for renewable sources of supply and the promotion of sustainability as an integral purpose of building design continues to filter through to create new forms and constructional technology. All new buildings will be touched by these policies which are largely effected through the Building Regulations. It now requires a positive choice to minimise waste and maximise sustainability. This can both drive the design of a building and be used in the expression of the building form. *A bit about lighting here?*

Public policy has also set the pace for making sure that disabled people are not left at a disadvantage in access to and use of new buildings. Equality is an important force in today's democratic society. Equal access is a fundamental right and in new design solutions buildings should incorporate accessibility for disabled people on equal terms with able-bodied as an integral part of the design concept. New building forms may be desired both for the functional requirements of access and for the expression of an open and democratic environment.

Disabled Access

Access for disabled people

Equality is an important driver of today's democratic society. Equal access is a fundamental right and in new design solutions buildings should incorporate accessibility as an integral part of the design concept. New building forms may be derived from both the functional requirements of access and the expression of an open and democratic environment

General guidance and references to regulations and legislation which covers provision for disabled access are given in **Accessibility for All**

A summary of the likely points that can be expected to be relevant to alterations and extensions is given below:

Disability Discrimination Act 1994 (DDA)

Imposes a duty of those providing services to the public to ensure that the service are as readily accessible to disabled people as to others. Since 2004 it has been required that service providers make reasonable adjustments to the physical features of their premises to overcome barriers to access. The provider and designer should consider the following:

- **Car Parking** : Adequate space, suitable surface, disabled marking if reserved.
- **Paths** : Distinct separation from vehicular routes, suitable surface, dropped kerbs, appropriate width, unobstructed passage, handrails on slopes steeper than 1 in 20.

Sustainability

Although the criteria already established for designing with sustainability in mind relates to all kinds of building activity there is a much greater need today for conscious responsibility in contemporary design when using materials sourced from all over the world and technologies that depend on much off-site preparation. The problem for the designer is to discover what the environmental costs of production and transport of materials has been, as well as the future implications of incorporation in the building of materials perhaps relatively untested by time and environment. It requires a positive choice to minimise waste and maximise future benefit from robustness and adaptability. This will be a major influence in the design of the building and in the expression of the building form.

A fuller discussion of the efficient use of resources and other aspects of designing for sustainability is contained in the section **Sustainable Construction**. This is an important and far-reaching issue and includes consideration of :

- Site design, orientation, environmental impact
- Minimising wastage
- Minimising waste in production, transport incorporation and use
- Pollution in production and use
- Renewable energy
 - Renewable energy (remove double)
- Biodiversity
- Water and drainage
- Social and Economic Sustainability

Building Regulations

Part M applies generally to new work to domestic property and to buildings where access is intended for the public. It is very likely that the regulations will be up-dated from time to time but their operation cannot be applied retrospectively.



Northumberland Coast AONB Design Guide for the Built Environment

Landscape, Planting and External Detail



There is much delight to be had both by residents and visitors to the AONB from the robust and careful detailing of the spaces in our settlements and from the way developments are contained within the landscape. A response to slope, view, sun and shelter may generate important decisions about the placing and form of a building and its relationship with the space around it. So too a response to the context of the site and the character of the buildings nearby it will suggest the kind of detailing appropriate for hard surfaces, boundary walls and gates and planting design. In the case of intensified car parking at popular sites the landscape work may involve substantial earth shaping to assist in screening vehicles, but this must take account of hydrology, drainage and the ecological impact on surrounding land.



The AONB Management Plan includes :

Policy LP6

Where landscaping forms part of a development it should be in keeping with the character of the surrounding landscape, mitigate against detrimental impacts on, and where possible enhance, views within and into the AONB, and, where planting is involved, make use of native species appropriate to the location.

Policy LP14

Improve the visual impact of existing car park facilities and follow AONB guidelines and standards for design and location in any new car park facilities.

Land Form

It is so easy to bring in heavy machinery to a sloping site and level the ground to suit a building designed for a flat site. Never mind the awkward banks at the edges of the cut and the prominent front of the new platform: these can be propped up with heavy retaining walls or smothered with shrubbery planting. But do we need to disturb the natural land form with such heavy earthworks? Our predecessors with less powerful equipment paid more respect to the natural contours of the land and adjusted the building design to take account of them.

The siting of a building may well be constrained by other factors than land form but it is as well to consider how to use the contours and folds to obtain the best positioning with the minimum disturbance to the natural landscape of the site. In this way a proper understanding of the characteristics of the site is really the first thing the developer needs to seek in the design process.



Older buildings respected site topography and were influenced by the land form as in this example at Cheswick near Berwick

However, much of the AONB is relatively flat anyway and the main purpose of land forming works is more likely to be to improve screening of potentially unsightly development or installations: to create banks round sewerage treatment plant or oil storage tanks or to reduce the impact of car parks in the open land outside villages or behind popular coastal beauty spots. Here the design of the earthworks should be conceived as far as possible to create shapes that flow from surrounding land-forms that will naturalise quickly and seamlessly with their setting.

Often earthwork mounding reinforced with planting can be used to sub-divide areas of car parking so that groups of cars might occupy smaller spaces with a sense of privacy and quiet. This sub-division will also improve the screening from more distant viewpoints.

Tree and Shrub Planting

Tree Cover

The coastal climate of Northumberland limits the growth of woody plant material significantly and restricts the range of suitable species to a large degree. However trees and shrubs form an essential element of most of the village landscapes of the AONB and are a major factor in the variations found on the wider agricultural landscape (see the Landscape Character Appraisal section).

As vegetation is relatively slow growing in the exposed maritime environment any existing trees or larger shrubs should be retained and treated as part of the context of the design. The vigour and life span of old trees can often be extended by tree surgeons. Care should also be taken to avoid damage to roots during a building operation either from foundation or drainage trenches or by raising or lowering the ground levels significantly close to the tree.

Most development will benefit from planting particularly in terms of creating shelter, screening and most important of all, generally integrating new development into the local landscape pattern. In all cases new planting is valuable for the contribution it makes to the future landscape of the AONB.



In the major settlements trees are a dominant element in public spaces and in larger gardens; in some instances the villages often contain more trees than the surrounding landscape, the original seedlings have benefited from the shelter of buildings and the protection from grazing. Species are somewhat limited, with Sycamore and Ash the most commonly occurring large tree.



Trees form a dominant element of many of the older settlements such as Bamburgh

Planting of Sycamore can be a contentious issue. Its prolific seed production and dispersal characteristics can result in it rapidly invading adjacent gardens and plantations. However it could be considered in some settings (for example a large public space) where Ash, the other main alternative, is considered to have inadequate mass or density of canopy for the situation.

New planting

New trees should be planted with careful thought to their mature height and spread including a respect for the vigour of the root systems which can cause disturbance to the foundations of boundary walls, to path surfaces and drains if adequate space is not allowed.

Careful management and pruning is essential to achieve good shape and encourage vigorous growth for specimen trees and for hedges is a regular management for form and density of growth.



Trees contribute significantly to the scale and setting of development but selection of appropriate species is critical in terms of balancing the short term effect with the long term management requirements.

Tree and shrub planting can be very variable in success unless care is taken in species selection. A good first guide is to look at the surrounding landscape for successful species. Where possible choose native species for their value as a food source for wildlife (the same approach could also be applied to garden design – where appropriate consider the wilder, organic type of layout and use native plant material as first option).

The coastal exposure demands thicker belts of planting than would normally be the case. Where possible make hedges or shrub borders wider than would normally be the case for inland sites; young plants benefit from the improved shelter provided by wide, dense planting beds which filter wind more effectively. In most instances temporary supplementary shelter –windbreak material or tree shelters – a useful aid to effective plant establishment.



New planting can take a variety of forms. Where open views are to be retained, scattered staked specimen trees can be effective. However, large specimens are often slower and more difficult to establish than massed planting of smaller plants such as whips and transplants

Mass planting similar to this area at Seahouses should always be a first consideration where space permits and where maximum density for shelter and screening is the aim



The use of nurse species (such as Birch) which are eventually removed in the longer term as mass planting is thinned, should be considered for exposed areas.

In all cases a simple long term management plan prepared at the time of planting is essential. Professional advice from either a landscape architect or forester can be useful in the preparation of planting plans and the management of planting.

For further guidance check in the further references given over or seek advice from the AONB team who have further guidance documents.

Trees and Shrubs – suggested species

Note while this Design Guide is not intended as a planting manual it is suggested that plant material be selected with future health and vigour in mind with high root to shoot ratio, avoiding pot-bound root balls and choosing smaller younger stock which will establish more easily.

Native trees

Ash
 Common Alder
 Birch – 2 species (*Betula pendula* and *B. pubescens*)
 Willow – various species
 Scots Pine
 Rowan

Native Shrubs

Blackthorn
 Burnett Rose
 Dog Rose
 Guelder Rose
 Bird cherry
 Gorse – on whinstone and sandy soils
 Hazel
 Hawthorn
 Holly

Non-native Trees and Shrubs

for limited use where there is no native alternative (but the invasive nature of some species should be taken into account *)

Trees

Beech
 Corsican Pine (*maritima*)
 Swedish Whitebeam
 Sycamore *

Shrubs

Sea Buckthorn *
 Broom (*Genista* or *Spartium*)
 Hebe spp
 Rosa rugosa

Further reference : Northumberland Wildlife Trust Guide to Planting Native Trees and Shrubs – currently in its 5th draft.

Conserving Rural Character

While much of this might seem to be urging the case for extensive new planting, there are many situations where garden planting reaching out into the wilder or more natural countryside is inappropriate. The outward march of the ubiquitous hybrid daffodil along country lanes or the blooming of exotic flowers round chalets in the coastal sand dunes suggests the taming of the natural environment. The wide mown lawn and potted plants merely extends a suburban taste and is out of keeping with the habitat of the dunes.

Site Boundaries

Walls and the AONB Landscape

Stone walls stretching out from the buildings and settlements of the AONB are, as much as any other feature, the element that binds building and setting together. The walls of gardens and in-by fields form a spreading web anchoring the settlement to its ground.



The craft of stonewalling is still practised and though it is a slow and relatively expensive form of construction, the stone wall proves a durable investment. Many of our gardens today shelter within walls built in the 18th and early 19th centuries which have required or received almost no subsequent repair.

The stone is usually the rough hewn material from the same source as the finer dressed stone of contemporary buildings, probably the more weathered overburden of the same quarry. If it is more difficult today to obtain new local quarry material there is often a ready supply of salvaged material obtainable through builders or stone-wallers in the area.

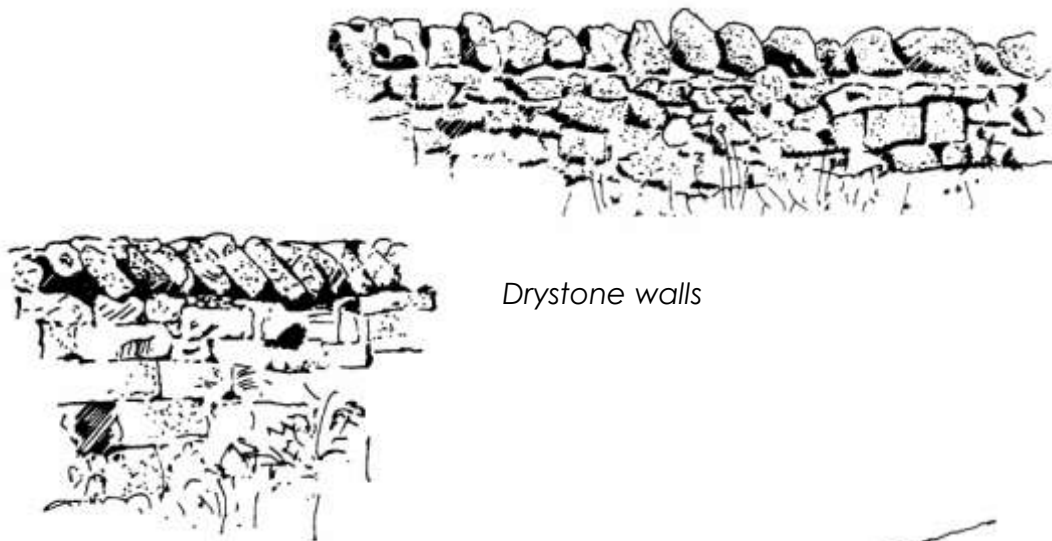

Drystone walls

Close to the house or in the building of higher walls for the garden it is best to build a mortared wall so that it can remain fairly slender and of constant thickness. This should incorporate a damp proof course at its foot and have a top capping also bedded on a damp proof course. Generally the coursing of stone walls should follow the contours of the ground.

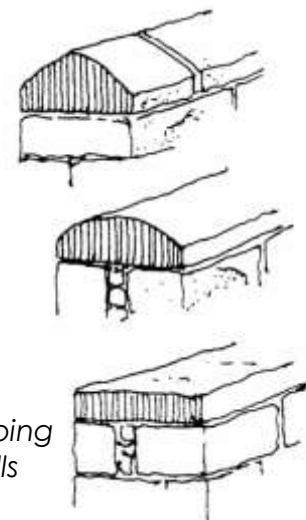

Various profiles of capping stones to mortared walls

At the settlement's edges where land has been taken out of agricultural use the boundary wall should be akin to the dry-stone field walls with slightly 'battered' i.e. sloping faces to give strength and the copings set tightly on top or bedded on an inconspicuous layer of mortar or turf.

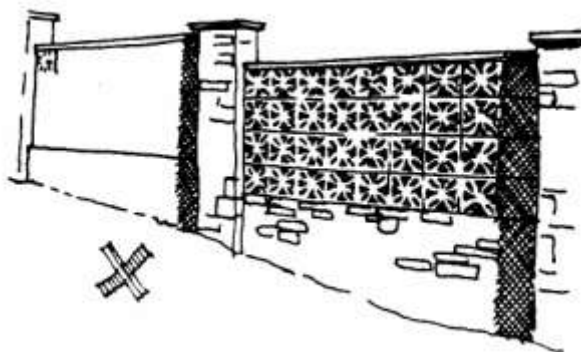

Boundary walls made in pre-cast concrete Spanish style are not appropriate in the AONB and there are many other sharply mechanical products which the designer should exclude from his palette.

Walls and Biodiversity

Stone walls, particularly dry-stone walls, are also valuable refuges for wildlife and are an opportunity for enhancing the biodiversity of a site. The dry conditions provide an ideal habitat for invertebrates and small mammals and a wide variety of plants (both native and ornamentals). If local stone is used plant, lichen and moss growth will reflect local geology and flora and reinforce the sense of local distinctiveness.



In these examples walls function as valuable microhabitats and provide a niche for both native and ornamental plants. They can also provide shelter for hedges and more fragile planting.





Many walls in the AONB are of great variety and age and closely reflect local geology and land use.

Sensitive modern development can also make a contribution to the local landscape.

In key locations such as Holy Island, re-use of materials has produced unique local details.



Fences, Gates and Barriers

Fences are of course much cheaper to erect than stone walls and may in many positions be adequate and appropriate. They do not achieve the same visual effect and are not so durable. If the fence is to keep livestock and vermin out of the garden it must be stoutly constructed and fitted with netting. Often a fence will be erected in order to protect a young hedge and will eventually become subordinate to the mature hedge.

Various types of fence are common in and around the settlements of the AONB ranging from timber post and rail with vertical palings, to timber posts with wire and netting. Sometimes when the need is only to prevent vehicles being driven onto grass a single rail with intermediate posts is sufficient deterrent, or a simple row of stubby posts.

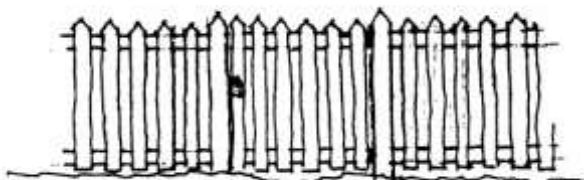
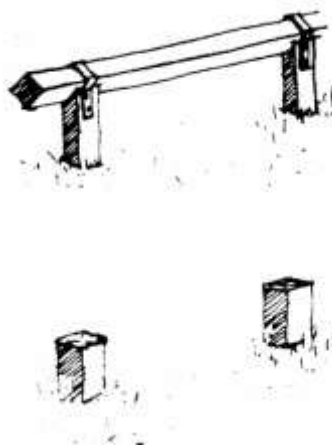
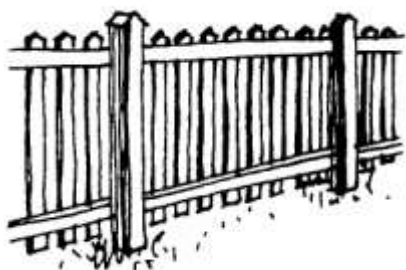

Gates in fences should reflect the style of fence. For gates in stone walls there is more freedom but some well tried types are good at excluding rabbits, now making a comeback.

Wider gates for drives do not necessarily follow the structural rules for wicket gates, as there is more of a tendency to distort with the weight of the wider span: whether the mooring of the gate is the traditional stone gatepost or a timber post the self-weight of the wide span gate requires very thorough packing in around the post to avoid settlement at the slamming edge. This problem can be overcome by a set of double gates. In these examples the planning authorities encourage the re-use of salvaged stone gate posts or stoops.

Oiled oak weathers nicely and is very durable

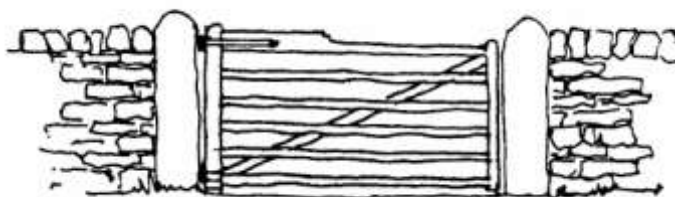

The diagonal bracing should rise from the bottom hinge to the top of the slamming edge



In some locations bollards or other barriers may be more appropriate than fences or walls; they also allow free movement of pedestrians and are particularly helpful where disabled access is an issue.



Plot Edges – Trims and Borders

One traditional feature of many of the historic settlements in the AONB is the maximum use of space in densely built up village centres, a pattern most clearly illustrated by the use of low plant borders and or cobble trims at the junction of walls and the highway or footpath. This satisfying detail provides a valuable demarcation strip, allows for changes in level, and provides an opportunity for a very positive contribution to the public realm.



Wearing Surfaces and Paving

One of the most satisfying aspects of the fabric of long established rural settlements is that so little in the way of external feature seems over elaborate or superfluous. This characteristic functional simplicity applies to footpath and paved areas, to the forecourts of shops and community buildings, to the edges and trim of roadways and to street furniture.

The quality of our village surroundings must very often justify the investment in good quality paving of natural stone flags and setts. If these are expensive it is often possible to economise by laying a single line of paving following 'desire' lines established by customary use, bordered with cobbles or cheaper concrete blocks.

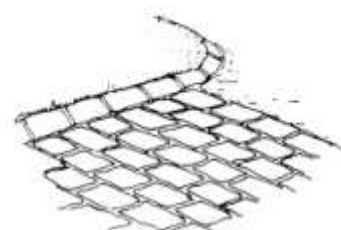

There are numerous alternative manufactured paving products for all applicants. Small setts can be used to line run-off channels between road and grass. Road verges can be defined with stone or specialised concrete blocks, though our country lanes are spoiled with heavy standardised concrete kerbs and gutter blocks.



The natural look of grass lying over the edge of the road surface is preferred. Car parking can be very intrusive, extending the area of hard surfacing beyond the access road surface but should be identified from it by a change in surface to smaller interlocking blocks or setts. The surface of the car parking area should be capable of withstanding the effect of power assisted wheel turning; rolled asphalt softened by hot sun and is a poor surface in such a location.



Driveways and Hardstandings – Sustainable Design Options

Unbound Surfaces



Unbound gravel incorporating a variety of aggregates can minimise the suburban character of parking spaces, particularly in longer drives or larger areas of surfacing.

A key consideration in selecting surfaces for drives and hardstandings is to provide a surface appropriate to the volume of traffic carried. A long tarmac drive for occasional use is wasteful in materials and can be intrusive in a natural setting where unbound gravel would be more appropriate. A thin layer of fine carboniferous limestone chippings on a typical Department of Transport sub-base will create a well drained hard wearing surface on level ground. Other fine gravels can be equally attractive but do not possess the chemical setting properties of carboniferous limestone. On steeper slopes chemical binders or resins may be necessary in order to avoid erosion but these may still incorporate locally occurring gravels.



Reinforced Grass

For a 'greener' finish in particularly sensitive locations, one could consider the use of grass reinforcement products. These can range from mesh systems (or other plastic or jute reinforcement) incorporated into the turf, to relatively rigid concrete or plastic grids with holes which allow the grass to grow through. Where the level of use is particularly low - for example fire paths - reinforced grass surfaces can provide an intermediate form of surfacing; however their use in overused or poorly drained locations can create an unsightly combination of bare compacted soil and concrete. The well drained sandy soils found near the coast make this option more feasible than would be the case on heavy clay soils (some incorporation of organic matter into soils is nevertheless vital for effective grass growth).

A thorough assessment of the intensity of use and good ground preparation is therefore essential for a satisfactory outcome. The concrete block systems are particularly disappointing in many poorly conceived and crudely implemented situations. Trip hazards in areas of high erosion are also a major concern with rigid systems. Reinforced grass should not be considered as an automatic alternative to simple unbound surfacing using local materials. The cost of the grid based systems combined with the necessary ground preparation is also often much higher than for gravel based solutions. It is therefore only one of a range of finishes to be considered for the hierarchy of routes and surfaces associated with rural development. Thoughtful delineation of use zones and careful selection of an appropriate range of materials and textures remains the essential key to achieving high quality layout and design.



Porous surfaces – Edge Details and Drainage

Both of the above alternatives reduce the unnecessary use of materials but also have considerable drainage advantages. Their porous structure reduces the need for run-off collection, minimises the need for piped storm water drainage and reduces peak flows in nearby watercourses in times of high rainfall. Intrusive edging detail, such as kerbs are also less necessary in most situations.

Drainage – Ditches and Channels

Irrespective of whether porous surfaces are used, drainage to ditches in rural parts of the AONB should be considered wherever possible. Piped drains in areas of windblown sand often clog up and become inoperative. Gullies incorporating silt traps or buckets are one solution but still require a high degree of maintenance. Where possible consider directing surface water run-off into shallow ditches; these can be cleaned out easily and also provide a micro habitat for local wildlife. In a more urban context channels formed using small setts create pleasing edge details. Run-off from hard surfaces can be directed to storage cisterns for re-use in plant irrigation.

Lighting

For most residential development external lighting will relate to the safe approach to the front door and other areas of pedestrian circulation round the house; the back yard, bin store, garage and outhouses, (See also **Conversions** and **New Building.**)

For more extensive landscape and garden design if lighting is needed to permit safe circulation and some degree of security, or to mark change in level, emphasis will still be upon avoiding light pollution and energy wastage. Bright lights shining into other people's homes can seem like trespass so the location, design and level of lighting for external enhancement must be carefully considered. Downward casting light fittings may include bollards with louvres or wall-mounted bulkhead lights with cowls that prevent misdirected light.

If the object of landscape lighting is to show the natural colours of vegetation then the white light spectrum is more suitable than sodium yellow. To avoid the cost of connection back to the house supply some home owners are using independent solar/PV lighting units; just don't get carried away with a Christmas lighting effect! The landscape is generally better viewed by daylight anyway.



Northumberland Coast AONB Design Guide for the Built Environment

Caravan, Chalet and Camping Sites



Caravan and chalet sites on the Northumberland Coast vary considerably in size, character and setting. Many sites claim to a long a history, the older chalet sites in particular dating back to early last century or even further. Dark timber or corrugated structures nestled into the fold of sand dunes at Embleton Bay and Low Newton and at Seaton Point near Boulmer have become part of the landscape while the larger and regimented caravan parks along the coast, mostly on the outskirts of settlements, have made little attempt at integration into the landscape, though many are long established.

This section is particularly aimed at the task of upgrading the setting and planning of existing caravan sites and meeting the new challenges thrown up by the growth in sustainable tourism.



Creating an appropriate site character

When making design and management decisions about holiday sites it is important to remember that visitors come to the Northumberland Coast because of the quality of the environment designated as an Area of Outstanding Natural Beauty. The character of the caravan site can contribute to that beauty or provide a contrast or at the extreme be a visual intrusion. Visitors are becoming more discerning as they compare the experience of other holiday destinations with ours. The quality of site facilities, the arrangement of caravans and the provision of good play space is an all important factor in making a site attractive. Nature conservation on caravan sites is becoming increasingly recognised as an important issue and contribute to visitors experience – as demonstrated by the annual David Bellamy Award Scheme which places a particular emphasis on wildlife conservation and resource management.



Use of this woodland setting for a small group of timber wigwams adds considerably to the sense of identity of the facilities and will improve the microclimate significantly by providing shade and shelter.

Key considerations when planning improvements will almost certainly spring from financial pressures. At first sight the maximum return would seem to be gained by using space as densely as possible with regimented rows of vans with little differentiation. However many sites contain large areas of open space which present opportunities for site improvement and for making a positive contribution to the local landscape and its biodiversity.

An audit of existing site assets

Many sites in the AONB contain valuable features such as the increasingly rare grassland found on whinstone outcrops, prominent areas of woodland and the occasional historic building. An audit of the existing features of a site is a valuable first step towards maximising the contribution of a site to the local environment. Professional advice may be useful at the outset in order to identify features which merit preservation or conservation. Contact the AONB team as a first step.

Opportunities for improvements

In addition to looking at the existing valuable features on a site, many benefits can arise from closer examination of the underused areas of land. Areas without an obvious use such as steep slopes offer opportunities for habitat creation either as wildflower rich grassland or for new tree planting. Existing hollows can be exploited for their poor drainage characteristics to create wetland or can be newly created as shallow scrapes (where health and safety consideration allow this). Even the site sewage disposal system outflow may offer opportunities for a reed bed treatment approach which combines practicality with a habitat creation ethos.

Tree and shrub planting

Boundary planting, often attached as a condition to planning consent provides a valuable opportunity for developing wildlife habitats as well as providing the intended screening function. The edges of woodland are important habitats in themselves, with an informal approach to grass cutting on edges a key issue – current research confirms that some areas of long grass are a prerequisite for increased insect and birdlife populations. It is also important to consider providing blocks of tree planting within the site itself, to improve the microclimate (providing shelter and shade), enhance biodiversity and to divide up the site into human scale zones. Internal tree planting can make a valuable contribution to the site landscape and contribute a significant screening effect for sites on prominent positions on hillsides.

Internal planting and low mounds can also play a vital role in reducing the visual impact of areas of caravans on level sites which are often difficult to screen. Old hedgerows and hedge banks should be retained where possible in order to achieve a similar effect. In this example on a site very close to the coast, tree cover is particular valuable.



Management of woodland areas

Good management of newly planted trees is particularly important in the demanding coastal climate of the AONB. A long-term management plan for site woodland is also essential in order to ensure that the current level of tree cover is maintained on the site in the future. A plan which avoids dramatic wholesale clearance of plantations or copses is preferable as is a general approach which develops an uneven age structure for the trees on a site. Diversity can be created in this way even with a relatively restricted choice of mature tree and shrub species.

This existing backdrop of mature woodland creates a very attractive setting. A key challenge is to ensure that the effect is maintained after the existing trees have reached the end of their anticipated lifespan. A long term woodland management plan for the whole site could be a sound investment for the future.



Site layouts

A common approach on many level sites is to adopt a rectilinear grid like layout, when this is not absolutely necessary. An organic layout can achieve similar densities but without the regimented impression created by rectilinear layouts. Organic layouts are often a necessity on sloping sites, with caravans and access routes arranged along contours; this can often help to blend caravans into the landscape.

Caravans set below the crest of a hill, in an organic layout which follows the existing contours of the site produces an effect which is less visually intrusive than formal layouts



Entrances

Welcoming entrances are usually provided by most caravan sites, the design and layout of facilities often being related to site management. Entrances also present an opportunity for an individual approach which reflects the ethos of the site. Although a well cared for impression is commendable, sites can adopt where appropriate a more informal (i.e. less suburban) approach to landscape design. The site context will probably be the key determinant here – a site within a village may need a greater level of formality and tidiness than one in a rural setting.

This relatively formal treatment of a caravan site entrance which is set in the centre of a village (in this case Seahouses) may not be as appropriate in a more rural setting.



Access roads

Surfaced access roads and areas of hard standing are required in order to comply with the Model Standards set out by the licensing authority. However, it is possible in most cases to produce a layout which possesses a hierarchy of routes, all designed and surfaced in a manner which reflects the level of traffic carried (this approach can often help visitors who are unfamiliar with the site, to find their way out). Porous surfacing materials are now becoming increasingly valued for their effect on surface water run-off and their use as an alternative to tarmac should be considered wherever possible. Run-off from all surfaces can be directed to reed beds or wetland where appropriate, or taken to cisterns for rainwater harvesting for landscape irrigation.

Siting of toilet blocks and other facilities

Where possible the site contours can be used to great advantage to provide locations for the often utilitarian structures containing these facilities. Topographic hollows and existing woodland can help to reduce the visual impact of toilet blocks, and screen other site clutter such as waste disposal and fire points.



Children's Play Areas

Children's play facilities are now becoming increasingly common on larger caravan sites; in rural settings natural timber equipment blends in to the setting far more easily than the brightly coloured metal and plastic structures found in urban playgrounds.



Caravan colours

In clear weather the tones of both landscape and seascape along the coast are often quite bright; light sand on beach and dune, and the bright flash of wave and spray, can have quite dazzling effects in summer. In winter however greys are predominant in mist and sea-fret. In these two opposite conditions therefore lighter tones of colours may be more appropriate and will no doubt be welcome in the caravan world where the argument has long been maintained that darker colours absorb more heat in sunshine. To avoid high reflectance however finishes where possible should be matt or eggshell finish rather than enamel/gloss.



Chalet sites

Chalet sites are part of the local character within the AONB, but repairs and replacements should be carefully managed, to retain them in the spirit of their original purpose as informal, summertime 'strip and dip' structures.

Many chalet sites along the coast have older structures approaching a point of dereliction. Replacement may well be preferable to attempting patchwork and unsightly repair. A high standard is required in terms of quality of structure and visual impact, respecting the following criteria:

- Any replacement should be like for like with the original structure, not exceeding the footprint or maximum height of the existing structure. Pitched rather than flat rooves are preferable.
- Repairs should be in the style of the original structure.
- A subdued matt grey green or brown would be the most appropriate colour to blend in with the natural surroundings rather than brighter glossy greens. A parallel tradition of black or dark brown finish to timber boarding is also recognised.
- The natural setting of most chalet sites is the undulating coastal sand-dune. In this context the owner should avoid introducing wide mown lawns or a large paved apron round the chalet. A narrow mown strip as a fire break is acceptable. Exotic plants and flowers including pot plants, climbers and hybrid bulbs are out of character with the dune landscape. Simpler planting of Burnett Rose and the encouragement of the natural wildflower carpet that is so characteristic of the coastal grassland should be the aim.



Timber wigwams

This increasingly popular solution to providing low cost, low impact tourist accommodation can be a less dominant alternative to the caravan. There are however key issues relating to layout and design which can create a less intrusive overall effect. These include:-

- Organic layouts closely linked to the natural contours of the site create far more variety and interest compared with the rectilinear approach which creates a row of identical shapes and colours.
- In some sites the wigwams are simply propped up on concrete blocks which have been used to level the site. Providing a fringe or skirt of local cobbles, or preferably wildflower or low shrub planting could link the structure to the ground and create a more satisfying detail. The wildflower approach could be ideal for allowing access for winter maintenance and providing the most attractive effect in the summer, at peak visitor times.
- Colour is a consideration on prominent or large sites where just one colour is repeated – many timbers weather to a very attractive pale grey. The temptation towards regular use or overuse of coloured stains and preservatives should be avoided if possible, but obviously depends on the manufacturers recommendations. There is a close affinity between this new form of timber wigwam and the much older tradition of the upturned boat. The dark bituminous coating or the grey sub-bleached timbers make a very appealing allusion to the functional origin of these structures.
- As with chalets the natural setting of the wigwam should not be lost in suburban detail of decking and excessive paved areas. Exotic plants and plant pots may detract from the more natural setting recommended above.



Lighting

If one assumes that most visitors to holiday sites along the coast have come from urban areas it may have to be recognised that they would not be comfortable in dimly lit areas or natural darkness. Site owners equally will be concerned for the health and safety of visitors at least to avoid claims for injury resulting from things not being seen. So holiday sites will have to be lit, that is accepted. But in rural locations excessive lighting can create light pollution which is becoming an increasing concern for planners, astronomers and all who love the dark night skies of rural England.

Low level lighting which directs the glow down towards surfaces should provide sufficient levels of light for safe circulation round caravan sites with only limited higher level, but still downward focussed, light posts at an entrance or in a car park. Lighting colour in this context should avoid the yellow sodium range which produces distorted interpretation of natural colours and flesh tones.

There is a strong case for seeking professional lighting engineer advice in the distribution of lighting and types of fittings to be selected.

Management Plan includes :

Policy LP21:

Avoid the proliferation of street lighting schemes and resist outside lighting associated with new developments and conversions outside settlements. Where, after taking the rural location into account, lighting is deemed essential for safety reasons, light sources should be targeted with minimum pollution beyond the object for lighting and of a design sensitive to the architectural character of the area.

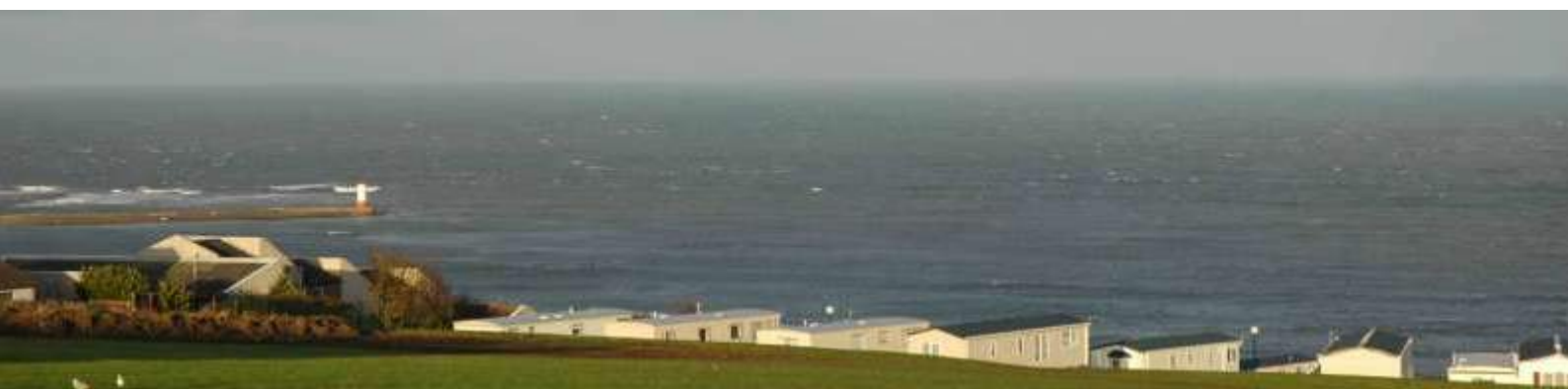

Northumberland Coast AONB

Design Guide for the Built Environment

Sustainable Construction

Sustainability – General Position

The reuse and conversion of existing buildings to provide accommodation types that are relevant for today's way of life is a fundamentally sustainable process, as many resources are recycled. The land, building structure and many of the original materials are likely to be reused, which reduces the volume of material for disposal.

New building work will require clearer analysis on the part of the designer of the impact of siting and orientation and the consequence of incorporating new materials and technology in the development.

The orientation of the building within the site will influence both the internal and external character of the building, the microclimate and the energy consumption. If possible, the building would be ideally positioned to take advantage of solar energy, avoid the worst of wind and driving rain, whilst preserving the potential for views.

Reuse of buildings and land

The conservation or reinvention of an existing building in its original setting will automatically involve the reuse of land that has previously been built on and avoid the use of previously undeveloped land.

New building work will involve site development either on land released from previous use – (referred to in shorthand as Brownfield Land) – or land that has had no previous development on it – Greenfield Land. For reasons of land economy and protection of the finite resource of Britain's undeveloped countryside the use of Brownfield sites is the preferred option for development, though problems may be met of residential pollution from previous use or structural weaknesses arising from disturbance or poorly compacted land fill.

The choice of foundations will have an impact on the site, and can influence the rate at which the land can be returned to its original state should the building be removed. The key consideration in the selection of foundations is in their structural performance, which will be influenced by a range of factors including ground conditions, size of buildings, and so on. Within these considerations, there is however scope to minimise the impacts of the foundations on the site:

- pad foundations use less material, and can be lifted out after use
- raft foundations should be avoided where possible, as these will disturb the entire area of the building footprint
- potential for the use of recycled material in the concrete, for example PFA

Minimising waste

Consideration of construction waste should be given at the early stages of a project. With conservation and alteration work there is unlikely to be any significant volume of excavation material but for new build and extension sites where it is necessary to demolish a redundant structure then more material is generated.

Sending waste to landfill sites is undesirable for a number of environmental and economic reasons. A far more sustainable response is for design for the use of recycled materials, and to put in place provisions for construction waste to be incorporated in the new development. A number of options can be considered.

- Minimise volume of excavation through consideration of building footprint and appropriate foundations
- Consider use of crushed demolition material in the hardcore for the building
- Consider separation, storage and re-use of the following components:
 - turf rolled
 - topsoil reused
 - seeds kept from existing plants
 - compost from existing plant matter
- Separation of waste streams that could be sold or used again elsewhere
- Reuse of spare materials on site – offcuts for shops, etc
- Delivering programmes to reduce length of storage time on site with risk of damage and subsequent disposal as waste.

Arrangements with suppliers can result in a reduced environmental impact through improved efficiency and a reduction in waste to landfill. The following criteria could be considered:

- delivery of building materials:
 - allow for inspection of materials
 - reject / return defective materials
 - return protective packaging
 - agreement with plasterboard manufacturer that waste will be collected and re-used
 - consider timing of delivery to avoid storing materials on site, and reducing the risk of damage and waste
- use of multi-use pallets, preferably in recycled plastic, for protection and storage of materials, to reduce damage and waste
- use of existing markets for refurbishment waste to reuse unwanted materials, including windows, timber, bathroom suites and kitchens

The use of reclaimed materials will result in a significant reduction in the embodied energy of the project. This involves minimal processing between demolition of the original building and construction of the new building, as opposed to recycling.

If a building has been detailed in such a way that it can be dismantled and the components reclaimed and recycled or re-used at the end of its lifespan, then this will have a positive effect on the embodied energy of both the original and future buildings. This will also reduce the volume of construction and demolition waste sent to landfill.

Where new materials are being specified, consider the possibility for inclusion of recycled elements, for example, recycled cellulose insulation.

Sustainably managed sources should also be used wherever possible. In terms of timber, for example, the FSC or PEFC logo will ensure that the forests are managed responsibly.

Systems which have been developed to use a reduced volume of materials, such as timber I-beams rather than solid beams, should be considered.

The most effective way to reduce the consumption of resources within a project is to design for durability, to reduce the amount of maintenance required and to increase the length of time between replacement intervals. This is itself a characteristic of traditional building construction.

Minimise energy in construction and use

With projects involving conservation or alteration the orientation of the building will be, to an extent, predetermined. If the building's function is changing, or an extension being added, there may be an opportunity to orientate certain spaces to take advantage of solar gains.

The potential for the use of passive energy will also be, to an extent, predetermined. There may, however, be an opportunity to retain and enhance the traditional lighting and ventilation strategies.

With new buildings the three dimensional form of the building can reduce energy consumption through a reduction in exposed perimeter compared with the enclosed volume, or through the incorporation of elements such as atria, courtyards, sunspaces, etc.

Environmental sustainability can be addressed through the incorporation of passive energy features into the form of the building. The use of day lighting, natural ventilation and passive heating and cooling will produce a low energy building with reduced environmental impacts, whilst still achieving comfortable internal conditions for occupants.

Various devices could be included in a design, for example:

- atrium
- courtyard
- area of glazing optimized for balance between day lighting against heat gains and losses
- narrow floor plates
- thermal mass

The microclimate surrounding the building can influence the operational energy consumption, and the following design considerations could be applied to a new building:

- consider influence of building form on localised wind patterns
- avoid blocking light / views to neighbouring properties
- where possible, site building to take best advantage of existing features and topography to influence wind patterns and driving rain
- consider provision of shelter from additions such as trees, fences, earth forms, etc, to reduce heat losses from the building, and to create pleasant outdoor spaces

The selection of materials will influence the embodied energy of the project, which consists of the energy used for the following processes:

- extraction of raw materials
- manufacture of building materials
- transport energy between stages of manufacture, and to construction site
- construction
- demolition / destruction
-

The component of the embodied energy will be less than that used in the operational life of the building, but will still be significant and should therefore be addressed during the design process.

Responsible sourcing of building components, specification of natural materials and limitation of transport distances are key considerations in the reduction of embodied energy.

The traditional building materials used in the past have low levels of embodied energy, being natural with minimal processing, and locally sourced to minimize transport energy. The use of these materials in a development will therefore have benefits in terms of a low embodied energy approach.

The use of “new” materials can potentially increase the embodied energy content of an original building. This can be avoided through the use of local timber, or through the use of reclaimed or recycled materials that also have the potential for re-use after the end of the building's lifespan.

There will be a degree of environmental impact associated with the processing of any building materials and products, across the whole life cycle of each component. There will be resource depletion and potential pollution during the extraction of raw materials, with a further risk of pollution during the manufacturing of building products. Energy will be required at each stage, for processing materials, and for transport and distribution both between stages of manufacture, and delivery to site.

To minimise these environmental impacts, the following criteria should be considered:

- ensure procurement is consistent with Northumberland National Park Authority's “Sustainable, Fair and e-Procurement Policy” dated 23rd March 2005
- reduce volume of goods ordered through, for example, organisation of site procedures, re-use or repair of existing materials wherever possible
- specify products from sustainably managed sources, which use minimal volumes of raw materials, and promote fair trade
- consider the whole life cost of products – for example, a higher initial capital outlay on a high specification building fabric may save money in the long term through reduced heating bills

- source materials locally where possible to invest in the local economy and reduce transport energy
- select products free from ozone depleting substances, solvents, Volatile Organic Compounds, etc, to reduce pollution and provide a healthy indoor environment
- consider products with the potential for re-use or recycling to avoid landfill
- consider use of reclaimed or recycled materials

To address the energy used in the construction phase of a new building, the following could be considered:

- minimise air and water pollution during construction processes, in accordance with Best Practice guidelines from Building Research Establishment, Department of Trade and Industry, and The Environment Agency
- use of timber from sustainable sources for site hoardings or formwork
- consideration for neighbours – distribution of introductory letters, keeping site working hours within those appropriate to the area, etc.
- consideration of Considerate Constructors Scheme, if appropriate to a particular project
- include relevant clauses in the Prelims to ensure that the contractor must adhere to best practice guidelines

Pollution

Indoor Air Quality

There are no concerns over the release of toxins, Volatile Organic Compounds, etc to the interior if traditional building materials and finishes are used in a development

The use of modern construction materials are not so environmentally benign, however, and can result in chemicals being released to the interior of a building, to the detriment of the occupant's health.

To avoid problems such as Sick Building Syndrome, or increased asthma cases, the building materials and finishes should be considered carefully. Natural materials with minimal manufacturing or processing will have least potential for negative impacts on the indoor environment, and components such as carpets, paints and wood preservatives should be carefully considered.

Atmospheric Pollution

The widespread availability and use of electricity is a relatively recent phenomenon, and would not have been relied on in the original buildings in the AONB. The modernisation of these buildings is likely to introduce a new rate of energy consumption, and with it an increase in atmospheric pollution.

The degree to which the building will cause pollution will depend on a number of factors, including:

- the chosen fuel source
- the efficiency of the building fabric and systems
- the use of passive energy

The most effective way in which to eliminate pollution is to reduce the energy demand from the building. This can be achieved in a number of ways:

- increasing the insulation levels in the building fabric
- upgrading the specification of the glazing
- maintaining and enhancing the traditional natural light and ventilation strategies
- efficient energy systems, for example heat recovery, use of condensing boilers, etc.
- siting development near public transport routes to reduce dependency on car travel

Renewable Energy

New building forms have historically been driven by advances in building technology. Recent innovations in the efficiency of solar, wind, and biomass technologies allow designers to incorporate these elements into the very fabric of a building. They can both drive the design of a building and be used in the expression of the building form. New building forms which maximise the efficiency of the technology can now be explored.

The use of renewable energy technology is to be encourage with the integration of solar panels for hot water or photovoltaic panels for production of electricity energy. These should be used to maintain the simplicity of the roof form and should stretch from ridge to eaves or gable to gable rather than being 'planted' on the roof as an object.

Solar panels

Solar panels generate hot water from solar energy for use in sinks, basins, showers, laundry etc. within the building. Various system configurations are available, but in most cases a secondary heat source will be required to ensure the desired water temperature in the absence of sunlight.

The optimum efficiency in the UK is achieved when panels are south facing, and mounted at an angle between 15 and 50°. 90% of the predicted maximum output will still be available if panels are mounted at an orientation between south-east and south-west, in the range of 5-50°. Shading of the panels by adjacent buildings, chimney stacks, vegetation etc. must be avoided.

In a new build project, there is the opportunity to form the roof of the building to incorporate the panels for optimum efficiency and minimal aesthetic impact.

As an approximate guide, each 1m² of solar panel will generate around 600kWh per annum.

Photovoltaics

Photovoltaics generate electricity from solar energy, which can be linked to a particular function within the building, the general electricity supply for the building, or can be linked to the National Grid.

In a new building, it may be possible to incorporate photovoltaics into the roof or façade as a component of the overall concept.

As for solar panels, the optimum location is south facing, at an angle between 15° and 50°. Again, it is critical that the panels are never in shade. Efficiency of the panels is related to the type of silicone used, but in general will generate approximately 145kWh per m²

Wind Turbines

Small scale turbines are available that make use of this natural resource to generate clean, renewable electricity. Various configurations are available as illustrated.

As a rough guide, a 2m diameter turbine will produce 4,500 kWh per annum, which would be enough to heat the domestic hot water in a typical house.

The appropriate siting of a wind turbine is critical in terms of the operating efficiency, power output and economics. Detailed information on the appropriate siting of a turbine is available from the British Wind Energy Association.

It may be possible to use the geometry of the building to enhance the performance of a turbine, for example through channelling the wind through a tapering gap to increase speed, and power output as a result.

Alternative technologies with minimal visual impact include:

Biomass: the use of wood fuel to supply space heating and/or domestic hot water: mains gas is unavailable in large parts of the AONB and in these circumstances the typical approach is to provide space heating and/or domestic hot water through an oil fired, LPG or Calor gas system. An environmentally viable and economic alternative could be to use biomass, which involves the burning of wood fuel to heat water for space heating and/or domestic hot water.

Burning of wood fuel releases no more CO₂ during combustion than that which has been absorbed during the growing phase, so the system is considered to be carbon neutral. The transport of fuel can add emissions and should be considered, but the overall effects are likely to be negligible.

Boiler housing will be required, and this is likely to be larger than a conventional system. A water-tight store will also be required to take bulk deliveries of wood fuel, which are typically in tonnes at a time. It should be noted that this system will require a greater amount of input in terms of operation and maintenance as compared to a conventional alternative and many timbers leave deposits of wood tar in the appliance flue which can be difficult to remove.

Geothermal: used to supply low level energy heating and / or cooling, requires an adjacent area of free land in which to bury pipework coils: if there is an area of open land associated with the building, then a ground source geothermal system could be considered.

Low grade heat from the ground is converted to temperatures suitable for space heating, to provide a viable alternative to the use of fossil fuels. Temperatures in this system tend to be slightly lower than for a conventional heating system, and would therefore not be considered suitable for domestic hot water. This is, however, ideal for use with underfloor heating.

A system such as this would have minimal visual impact once in operation. Housing for the heat pumps would be required, but tends to be unobtrusive as these are relatively small, stackable elements. The most significant impacts arise during installation, when an area of land would be disrupted. After installation, the topsoil, turf, etc. can be replaced and the landscape be reinstated in a short timeframe.

Micro hydro: a small scale turbine is positioned in a stream or river to produce clean renewable energy: small scale turbines can be placed in existing rivers or streams to generate electricity from a renewable source. It is recognised that these sites will be rare in the AONB with its relatively flat landscape. The available power is related to the flow rate and the difference in level (head). Lower head systems, i.e. with a shallow gradient are possible, but may require additional infrastructure, while systems with a sufficient fall can be more efficient, even with a lower volume of water. Each potential site would have to be assessed to determine feasibility and the available power, based on flow rates, available head, seasonal flow

characteristics, etc. The Environment Agency would also have to be approached for relevant permissions.

Suitability of a particular technology would have to be assessed for each individual installation. There are a range of issues to consider, including the available natural resources on site, the likely visual impact, and the requirements for delivery of fuel, maintenance, etc.

Grant funding may be available to support the installation of these technologies. (Refer to the References and the Links section in Appendix A for further information.)

Biodiversity

- Existing features in site, such as trees, bushes, planting, etc, should be protected during works
- Temporary storage around the site for topsoil, plants, seeds and compost and their reinstatement on completion would preserve the character of the site
- Increase biodiversity through the planting of native species to attract insects and wildlife
- Increase biodiversity with the design of sustainable drainage systems (SUDS)

Water and drainage

Supply

- Upgrade bathroom and/or kitchen fixtures and fittings to modern equivalent with low water consumption including:
 - Spray taps
 - Low flow rate showers (<9 litres/min)
 - Low cistern volume WCs
 - Economic dishwashers / washing machines

Drainage

- Connect to municipal sewage system for foul drainage, if possible
- If there is no available public drainage system, a package treatment plant would be the next consideration. Septic tanks should be considered only as a last resort
- Solutions such as composting toilets and reed beds are ideal in environmental terms, however, would require maintenance and upkeep by the users. This is generally an unpleasant and undesirable task, and should only be considered in situations where conventional sewage solutions are unavailable, and where the client has requested it and has a full understanding of what will be involved
- In accordance with Approved Document Part H of the Building Regulations 2000, the first option for surface water disposal should be the use of sustainable drainage methods (SUDS) which limit flows through infiltration – soakaways, swales, ponds, porous paving, etc.
- Reduce volume of external surface water drainage through arrangement of landscaping, consideration of green roofs, etc

Grey water

- Consideration of rainwater harvesting for applications including flushing of WCs and irrigation
- Grey water collection from sinks, basins, baths, etc, and re-use is the less favoured option, and is likely to be appropriate for only a small minority of projects

Social and economic sustainability

The availability of transport options will depend on the location of the existing building and is likely to be a consideration, although not the determining factor, in the assessment of the site's suitability.

The availability of facilities such as schools, healthcare, etc will also be predetermined by the location of the building, and should also be given due consideration during site selection.

The character of a building in its context, and in relation to its neighbours, can influence its ability to be seen as a component of the setting. This is likely to be relatively easily achieved in projects of this nature, and traditional building forms, locations and arrangements are being conserved.

- Provision of shared external space for clothes drying, children playing, village green, etc, can have positive impact on the quality of life in the area and increase a sense of community
- Unity of building styles and arrangements where appropriate to benefit local economy

Sustainability – References and Links

The following websites offer further information and guidance in terms of sustainable design:

- “Building-In Sustainability”, Durham Council:
<http://www.buildinginsustainability.co.uk/bis/usp.nsf/pws/building-in+sustainability+-+building-in+sustainability+-+home+page>
- Northumberland National Park Procurement Policy:
<http://www.northumberland-national-park.org.uk/AboutUs/Policies/ProcurementPolicy.htm>
- Sustainability in the North East of England:
<http://www.sustaine.com/>
- Minnesota Sustainable Development Guide:
<http://www.sustainabledesignguide.umn.edu>

Grants for the installation of renewable energy technologies are available from the following sources:

- Clear Skies – renewable energy projects for individual homes or communities:
<http://www.clear-skies.org/>
- Community Energy – district energy projects using any fuel type:
<http://www.est.org.uk/communityenergy/>
- Major Photovoltaic Demonstration Programme – photovoltaic projects on a variety of scales:
<http://www.est.org.uk/solar/>
- Carbon Trust – grant for research and development projects:
<http://www.thecarbontrust.co.uk/carbontrust/>
- Enhanced Capital Allowance – energy efficiency grants for businesses:
<http://www.eca.gov.uk/>
- Energy Saving Trust – grant and information for households:
<http://www.est.org.uk/>

The following information sources may be of use in planning for energy efficiency:

- Education – Energy Consumption Guide 54 “Energy Efficiency in Further and Higher Education”, BRESCU, 1997
- <http://www.thecarbontrust.co.uk/energy/pages/publicationsearch.asp>
- <http://www.constructingexcellence.org.uk/>

The Building Research Establishment's Environmental Assessment Method (BREEAM), or equivalent standard for residential (EcoHomes), can be used to quantify the environmental performance of a project, at a number of key stages in its lifespan. For further information, please go to: <http://www.breeam.org/>

Northumberland Coast AONB Design Guide for the Built Environment

Accessibility for All

Disability Discrimination Act 1995 (DDA)

This is an act introduced to end the discrimination that many people face. Since 1995 the Act has been amended to introduce new rights and many of these rights have implications for the built environment. The impact of these are constantly being monitored and are likely to be updated from time to time.

It is important to understand that the DDA is different to the Building Regulations in that it does not directly require accessible environments to be provided for disabled people. The rights are for access to employment and for access to goods, facilities and services, rather than to the building in which these are made available. There are a variety of ways in which employers and service providers can ensure they are not discriminating against disabled people and not all of these will entail a change to the physical environment. A 'physical feature' includes anything arising from a building's design or construction of from an approach to, exit from or access to a building.

Building designers, whilst not legally required to respond to the DDA should anticipate its requirements and design buildings accordingly. Those commissioning new buildings or adaptations to existing buildings are well advised to consider the implications of the DDA in terms of their ability to employ or offer goods and services to disabled people on an equal basis.

Since 2004 it has been expected that service providers make 'reasonable adjustments' to the physical features of their premises to overcome physical barriers to access. (Experience shows that the majority of adjustments which employers are likely to have to make would not relate to physical features.

Access Audits

An access audit is a useful starting point in assessing the current state of accessibility and usability of an existing building by disabled people.

Building Regulations

Part M of the Building Regulations has specific requirements for access for disabled people, not only to buildings used by the public, but also some requirements as far as both new and extensions of existing domestic properties are concerned. It is likely that these requirements will be updated from time to time and current advice should be obtained from the Building Inspectors of your local authority when considering new build, material alterations or extensions to property. Only in exceptional circumstances will a Building Regulations Application be approved if the requirements of Part M are not met.

However, the need to conserve the special characteristics of historic buildings needs to be recognized. In such work the aim should be to improve accessibility where and to the extent that is practically possible, always provided that the work does not prejudice the character of the historic building, or increase the long-term deterioration to the building fabric or fittings. In arriving at an appropriate balance between historic building conservation and accessibility, it would be appropriate to take into account the advice of the local authority's conservation and access officers, and English Heritage in order to make the building as accessible as possible.

Physical characteristics of a building or extension which still complies with Part M of the Building Regulations in force at the time the building works were carried out are not required to carry out further alterations to comply with newer regulations.

An approved Document has been approved and issued by the Secretary of State for the purpose of providing practical guidance with respect to the requirements of Part M. This provides guidance for some of the more common building situations, but there may be alternative ways of achieving compliance with the requirements. There is no obligation to adopt any particular solution contained in the Approved Document if you prefer to meet the relevant requirement in some other way.

English Heritage Access Policy

English Heritage is the lead advisory body on providing access to historic buildings in England. They believe that access should be celebrated with high quality design that is also sensitive to the special interest of historic buildings. They encourage those who own or manage historic buildings, or other heritage properties, to adopt access plans that are consistent with the special architectural, historic or archaeological interest of the property concerned.

English Heritage and Heritage Lottery Fund are committed to achieving and improving physical and sensory access to historic landscapes, by balancing the demands of access and conservation. Some suggestions:

- Replacing existing gravel surfaces with self-binding gravel or by adding binding agents such as bitumen and resin
- Relaying stone setts with tighter joints, or pointing them to form a less recessed joint, or incorporating a level surface within them
- Introducing alternative routes and signing them accordingly
- Introducing alternative routes which give access to certain key features, and views within the landscape, while acknowledging that full access may not be possible
- Using interpretation and alternative media to provide intellectual access to those areas that will remain physically inaccessible

Commission for Architecture and the Built Environment (CABE)

CABE believes that good design is fundamental to higher quality buildings and open spaces. Function is one of the cornerstones of good design and accessibility is vital for a project to function well. Creating places and facilities that are accessible to everyone should not be seen merely as an afterthought, or as compromising other aspects of the overall design. Integrated solutions should become the automatic standard for all services and new developments.

The most obvious element of an existing building which determines its accessibility is its fabric or shell.

No building functions as an empty shell. Internal layouts fitting out, fixtures and fittings can be critical. This at first may not seem to be important for a Design Guide which focuses on issues relevant to Planning Application Guidance but for alterations, new buildings and extensions internal arrangements which assist in making a building accessible can affect the external appearance.

Existing buildings used in any way by the public should have an access audit done. Some of the issues highlighted by that audit as requiring action may affect the appearance of a building.

Any new building and any substantial alteration (will) require an Access Statement to be prepared as part of a Planning and/or Building Regulation Application. Advice on the need for and preparation of an Access Statement can be given by your local authority and the Disability Rights Commission will give further information and examples.

Public buildings need to be accessible to a wide range of users including people with mobility or sensory impairments, and people with learning difficulties.

With over eight million adults in Britain with some degree of disability and an increasingly elderly population it becomes ever more important that buildings are designed for optimum ease of use by their occupants and visitors.

Car Parking: Larger parking bays are required to allow people with reduced mobility to get in and out of their cars with the minimum of difficulty. It is necessary to provide these facilities for public buildings and other sites where car parking is provided, as close as possible to the facility being served. It would also be sensible in new housing development to provide sufficient space for easy access to and from cars, both for residents and for visitors.

Bays for use by the public should be clearly identified as for disabled people. Kerbs between parking areas and routes to the facility should be dropped. The car park surface should be smooth and even and free from loose stones.

Pathways: Routes should provide ample aural and tactile information as well as visual clues to help people with sight impairments. Pedestrian and traffic routes should be clearly distinguished using texture and colour. Surface materials should be firm, slip resistance in all weathers and well laid and maintained. (Cobbles and loose gravel are not recommended.) Path edges should be defined but by minimal changes in level.

Width of pathways should be considered for ease of use of those in wheelchairs – there should be sufficient space for people to pass others who are travelling in the opposite direction – and splayed or rounded corners provided where possible.

Cross falls should be no greater than 1 in 40 and handrails provided on slopes steeper than 1 in 20. Grids, gratings and covers should be flush with paving materials.

Planting should be trimmed to at least head height to avoid obstruction. It can provide scent and colour.

External signs: These should be carefully located so as not to cause obstruction, clear, well-lit, non reflective and logical.

70 to 75% of the information we received is given through eyesight. Anyone with a significant degree of sight loss, or no sight at all, will experience an information deficit. So it is crucial that signs maximize opportunities for visibility and legibility to make use of any remaining vision.

Signs hanging perpendicular to a building façade are useful

A sign should contrast with its background and the lettering should contrast with the sign board

There are four basic principles in sign design: signs should be used only when necessary; sign location should be part of the process of planning a building and the environment; messages should be short, simple and easily understood; signs should be consistent, using prescribed typefaces, colours and contrast and graphic devices.

Lower case (non-capitalised) lettering is easier to read. Light lettering on a dark background improves legibility for people with sight impairments.

Symbols should be used where appropriate.

To minimise glare reflective glass should be avoided and that the sign has a matt surface should be ensured.

Tactile signs, maps and models: embossed, Braille and audible signs can improve access for those with limited vision.

Sign Design Guide: a guide to inclusive signage by JMU and the Sign design Society is a very useful starting point (available from RNIB Customer Services).

External Lighting: Pathways, steps and potential hazards should be adequately lit, but should not create pools of light and dark. Lighting associated with steps should not cause anyone to negotiate steps in their own shadow.

Street Furniture: Avoid placing street furniture where it may cause problems for people with sight impairments or obstructs the passage of wheelchair users. Bollards should be a minimum of 1000mm in height and tonally contrasted with the background. Adjacent bollards should not be linked with chain or rope.

The provision of appropriate seating is important. Seats should be stable and be provided in a variety of heights, with and without armrests.

Cycle parking areas should be clear of the routes.

External ramps: These are essential to enable wheelchair users (and people with pushchairs) to overcome level changes in the public realm, and should be accompanied by steps for ambulant disabled people where steeper than 1 in 20. However, they are also an important consideration in assisting disabled and elderly people into dwellings.

In Part M of the Building Regulations, a gradient of 1 in 20 is considered level, 1 in 15 is adequate and 1 in 12 is an absolute maximum. The preferred gradient is 1 in 15 or less. The steeper the ramp the shorter the length must be between level landings. The impact of overall lengths and widths of ramps required to negotiate height differences is often underestimated. Ramps can have a significant visual impact on a building or landscape environment and need to be carefully detailed and integrated. Surface materials used, handrail design and colours employed will all need careful consideration.

External steps: Ambulant disabled people often prefer steps to ramps and they should always be provided as an alternative to ramps greater in gradient than 1 in 20. Step widths and heights are critical to ease of use.

Handrails should always be provided, preferably on both sides of the steps, however short the flight.

As with ramp surface materials used, handrail design and colours employed will all need careful consideration to comply with regulations.

Entrances: These should be easily distinguishable within the building façade and should relate well to access routes. The preferred aim in terms of access is to make a building's main entrance accessible to everyone on a permanent basis.

People will need to be protected from outward opening doors if they are not recessed into the building façade.

Doors in frequent use should have vision panels.

Clear opening widths, use of double doors and sliding doors, type of door handles and door closers, automatic opening mechanisms, and use of colour contrast are all design issues which will need to be addressed.

Entry thresholds should have a maximum change in level of 13mm but be flush if at all possible.

Exit doors, particularly those for emergency egress, are as important as entrances.

Lift Installations: The over ride requirement for maintenance of lifts above the lift car can have an impact on roof level in conservation work.

References and Links

Disability Discrimination Act (1995) by the Disability Rights Commission
www.drc-gb.org

Building Regulations Approved Document M (2004 – see summary below) published by TSO
www.tso.co.uk/bookshop
Tel: 0870 600 5522

British Standards Institution (BSI)
www.bsi-global.com
Tel: 020 8996 9000
BS5810: Code of Practice for Access for the Disabled to Buildings

Centre for Accessible Environments
www.cae.org.uk
Tel: 020 7357 8182
Provides technical information, training and consultancy in making buildings accessible for all users.

Royal National Institute for the Blind
www.rnib.org.uk
Tel: 020 7388 1266
A service provided jointly by The Guide Dogs for the Blind Association and RNIB. This is a pan-disability consultancy working to provide inclusive environments.

Royal National Institute for Deaf People (RNID)
www.rnid.org.uk
Tel: 020 7296 8000
Provides consultancy on the environmental needs of people with hearing impairments

English Heritage Publications
customers@english-heritage.org.uk
Tel: 0870 333 1181 (see summary below)

Sign Design Society
www.signdesignsociety.co.uk
Tel: 01582 713 556

Northumberland Coast AONB Design Guide for the Built Environment

Understanding the Planning Process

Introduction

Section 55 of the Town and Country Planning Act 1990 defines '**development**' as *'the carrying out of building, engineering, mining to other operations in, on, over or under land, or the making of any material change of use of any buildings or other land'*.

Some minor forms of development do not require planning permission, i.e. They can be undertaken under '**permitted development rights**' as set out in the Town and Country Planning (General Permitted Development) Order 1995 (as amended).

The policies of the Local Planning Authorities towards development and change of use of land are set out in the Local Development Framework. This document forms the basis against which the Authority will consider applications for planning permission.

If you are considering undertaking any form of development, it is always advisable to contact the appropriate District or Borough Council. The planning officers will be able to advise as to whether or not a planning application is required for the proposed development. They will also be able to advise whether other kinds of approval, such as **Listed Building Consent**, are necessary.

The planning officers always welcome pre-application discussions with potential applicants and are quite prepared to discuss the proposed development on site. This approach allows matters such as likely design requirements, materials and siting to be clarified at an early stage. The officers can advise on planning issues which are likely to be raised by the application and on the relevant planning policies which would be applied in the determination of the application. If potential difficulties are resolved at an early stage the planning application is likely to proceed much more smoothly.

Applications for Planning Permission

Most applications for development within the AONB would be for **full planning permission**. Only in exceptional circumstances would an outline planning application be considered acceptable. In these cases the Local Planning Authority would still expect to see illustrative details of the development.

Planning application forms are available from the planning officers at District and Borough Council Offices. The planning officers will advise on the number of copies of the application documents that must be submitted. This is dependent upon the number of consultations which will be necessary (e.g. County Highways Authority, Environment Agency, etc.)

Applications for planning permission must be accompanied by clear, accurate and suitably detailed drawings and plans. These will include a **location plan** (scale 1:10,000 or 1:50,000) and a **site plan** (scale 1:500 to 1:2500) showing the site to which the application refers and its boundary. The application site should be edged or shaded in red and any other adjoining land owned or controlled by the applicant edged or shaded in blue.

Other drawings should normally be to a scale of not less than 1:100. They should show the existing features of the site including any trees and be in sufficient detail to give a clear picture of any new building. The location of the proposed development within the site should be clearly indicated together, where necessary, with its relationship to other adjoining or nearby properties. Plans of existing and proposed layouts and elevations of the development must be included. Where existing and new works are shown on the same drawing, new work should be distinctively coloured. The plans should indicate the materials to be used in the external finish of walls and roofs and their colour and, where appropriate, the means of access to the site and the type of wall, fence or other means of access to the site and the type of wall, fence or other means of enclosing the site. In exceptional circumstances the applicant may be required to submit drawings showing the development in its setting.

A **Design and Access Statement** will also be required with most types of planning application. This is a report supported by illustrative material accompanying a planning application. It is intended to show how the applicant has analysed the site and its setting, then formulated and applied design principles to achieve good and inclusive design for buildings and public spaces. The statement's scope and level of detail is determined by the nature of the development, the site and its context.

It is advisable to use the services of a qualified architect for the preparation of plans together with a Design and Access Statement. A prescribed fee must be submitted with the planning application. The planning officers will inform applicants of the fee required.

Wildlife and Habitat Protection

All British Bat species are given special protection within England by their inclusion in Schedule 2 of the Conservation (Natural Habitats) Regulations 1994 and Schedule 5 of the Wildlife and Countryside Act 1981. Under the Wildlife and Countryside Act 1981 all wild birds, their nests and eggs are protected by law.

Surveys to establish the presence of bats and wild birds in existing buildings and to assess the likelihood of the buildings providing a suitable habitat for them must be undertaken by the proposing developer. The licensed surveyor will also include in a report recommendations for mitigating action to ensure the continued availability of suitable habitat for protected species. (One will be particularly needed where new development requires the removal of existing buildings or trees providing an established habitat for protected species.)

The local planning authority cannot grant permission for development without being satisfied that protected species are being protected and that mitigating measures are in place. The planning authority will advise the developer of the action to be taken in this regard.

Determination of the Application

Receipt of your application will be acknowledged within five working days. The planning application will be made available for inspection to members of the public at appropriate Council Offices. Site notices will be posted and where appropriate the application will be advertised in the local press. The planning officers will also consult other organizations, such as the Parish Council and the Highway Authority, and will notify any neighbours who may be affected by the proposed development.

In most cases the application will be reported to a meeting of the Planning Committee of the Council, who will determine the application after considering the advice given by the planning officers. Minor, non-controversial planning application may be determined under delegated powers by the planning officer. The planning application must be determined on sound planning reasons. Conditions may be imposed on the planning permission, usually to a standard format.

By law the planning application should be determined within eight working weeks. If there is a delay in determining the application the applicant's written consent must be obtained to extend the period for determination. If this is not done and no decision has been given within eight weeks, applicants can appeal to the Secretary of State for the Environment for non-determination. Appeals may take several months to decide and therefore continued discussion between applicants and the Planning Authority is preferable.

The Planning Authority must state their reasons for refusing planning permission or imposing planning conditions. If applicants are unhappy with the Authority's decision they can appeal to the Secretary of State. This must be done within six months of the date of the decision.

Listed Building and Conservation Area Consent

The Secretary of State for the Environment is required by the Town and Country Planning Act to compile Lists of Buildings of Special Architectural or Historic Interest.

Listed Buildings are divided into *three grades* according to their importance:

- Grade I** Buildings of exceptional interest
- Grade II*** Buildings of more than special interest
- Grade II** Buildings of special interest which warrant every effort being made to preserve them.

All alterations or additions to the outside of a listed building, including demolition, require Listed Building Consent before any work is carried out. Some internal alterations will also require Listed Building Consent.

If you own or occupy a listed building and wish to carry out any works of replacement, repair, alteration or extension, inside or outside, you should contact the planning officers for the appropriate council, who will advise as to whether or not Listed Building Consent is required.

The application forms for Listed Building Consent are available from the planning officers. Plans and drawings should be submitted showing full details of the proposed works, as specified above. It is advisable to employ a specialist architect to draw up details of any works to listed buildings.

Similar provisions apply for buildings within Conservation areas even where buildings are not themselves listed.

The Building Regulations do recognise the sensitive issue of working on historic buildings including specifically '*buildings of architectural and historical interest within National Parks, Areas of Outstanding Natural Beauty and World Heritage Sites*'. Building Inspectors will '*take into account the advice of the local planning authority's Conservation Officer*' particularly where work relates to '*restoring the historic character of a building that had been subject to previous inappropriate alterations e.g. replacement windows, doors and rooflights*'. In such work the aim should be to improve energy efficiency where and to the extent that it is practically possible always provided that the work does not prejudice the character of the historic building. The footnote on historic buildings also makes the important point that, the 'biology' of an old building is different from a modern structure and encourage '*making provision to enable the fabric of historic buildings to "breathe" to control moisture and potential long-term decay problems*'.

Northumberland Coast AONB Design Guide for the Built Environment

Case Studies

It is intended that this section is continually updated with new case study projects which are considered worthy of inclusion as good examples of work in the AONB.

Initially, a few suitable cases may be included from elsewhere (region, national , international?). You are asked to suggest examples for inclusion.

Case studies will be most suitable if they are of small scale development.